



Take home the
Breeze!



Let there be air!

Over the years, Venus has always pushed the boundaries and brought to you the best of innovation and technology in water heaters. Be it the range, the features or path breaking technology, we have ensured that our products make your lives more convenient.

With the spirit of innovation and quality always at our core, Venus now presents its range of reliable, durable and high speed fans that are popular across all segments. Read on to know more about our range of fans.





Blade Process

Shank Process

Coil Winding

Coil Processing

CNC Machining

Painting

Testing

Assembly

Venus

is a Consumer focused company high on quality and innovation. From 55 years, we have pioneered in the category of water heaters and have expanded to Fans, Irons and Air coolers, both for home as well as institutions encompassing consumers across geographies both domestic as well as overseas. From Water heaters, Fans, Irons, Air coolers and more, we have a diverse portfolio which is ever-growing. Today Venus is a trusted name in both households as well as the institutional sector and has been a dominant force across categories. A dynamic and growing network makes our products accessible across different consumer segments as well as different geographies.

State of the Art Manufacturing Facilities

Our State of the Art Manufacturing facilities at Tuticorin has deployed the most modern technologies, latest Machinery and standardized testing equipment and also the latest manufacturing processes to deliver quality products at the desired level of precision.

BLDC Fans have advanced DC Technology for trouble free performance and Easy operation

BLDC Technology

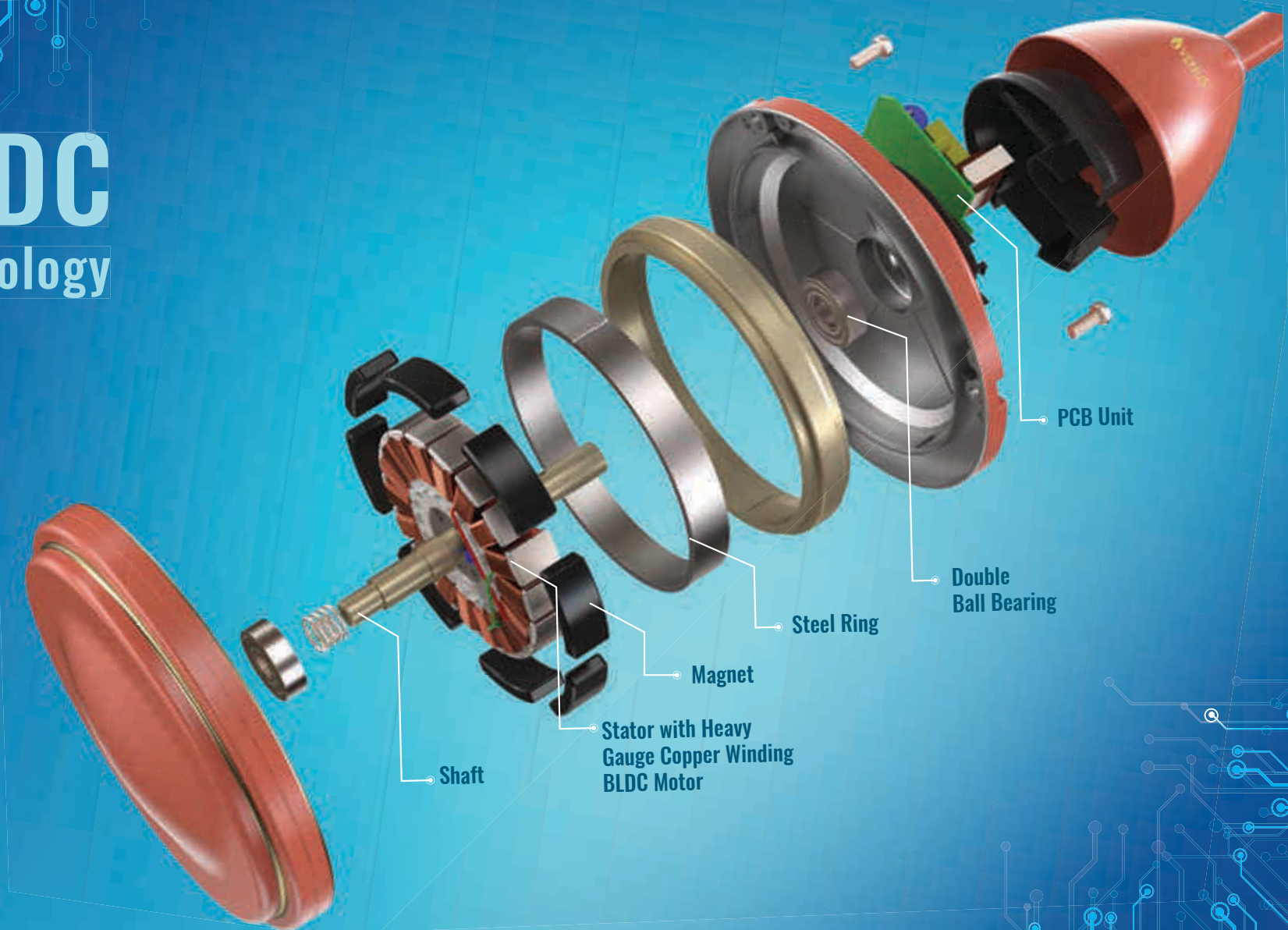

Energy Saving
56%



Consumes
Only 33
Watts

Halo ABS LED Fans

This Elegant fan comes with a regal design that gives a strong and silent breeze.

Air Craft Propeller Design for Better Air Thrust and Max Air Delivery

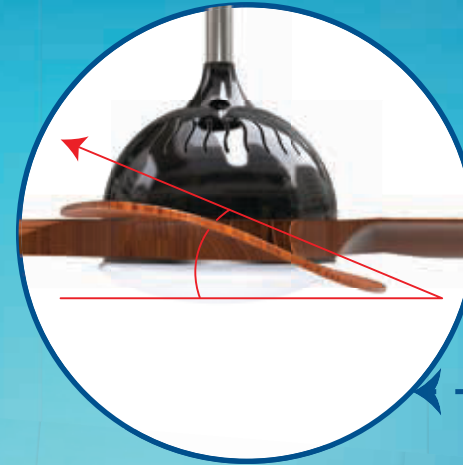

50% more angle than Ordinary Fans for a Strong Breeze

RUST PROOF ABS BLADE WITH PRECISE CURVATURE



Infinity Fans

The Stunning premium pedestal fan with a unique dual axis movement gives the ultimate experience of a cozy breeze.

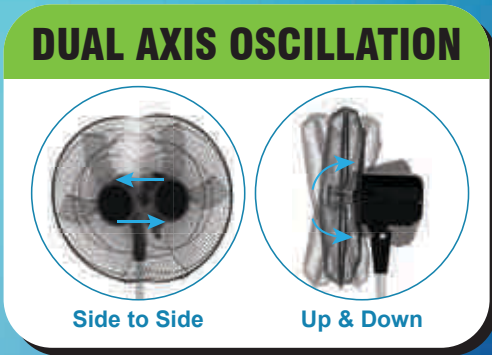
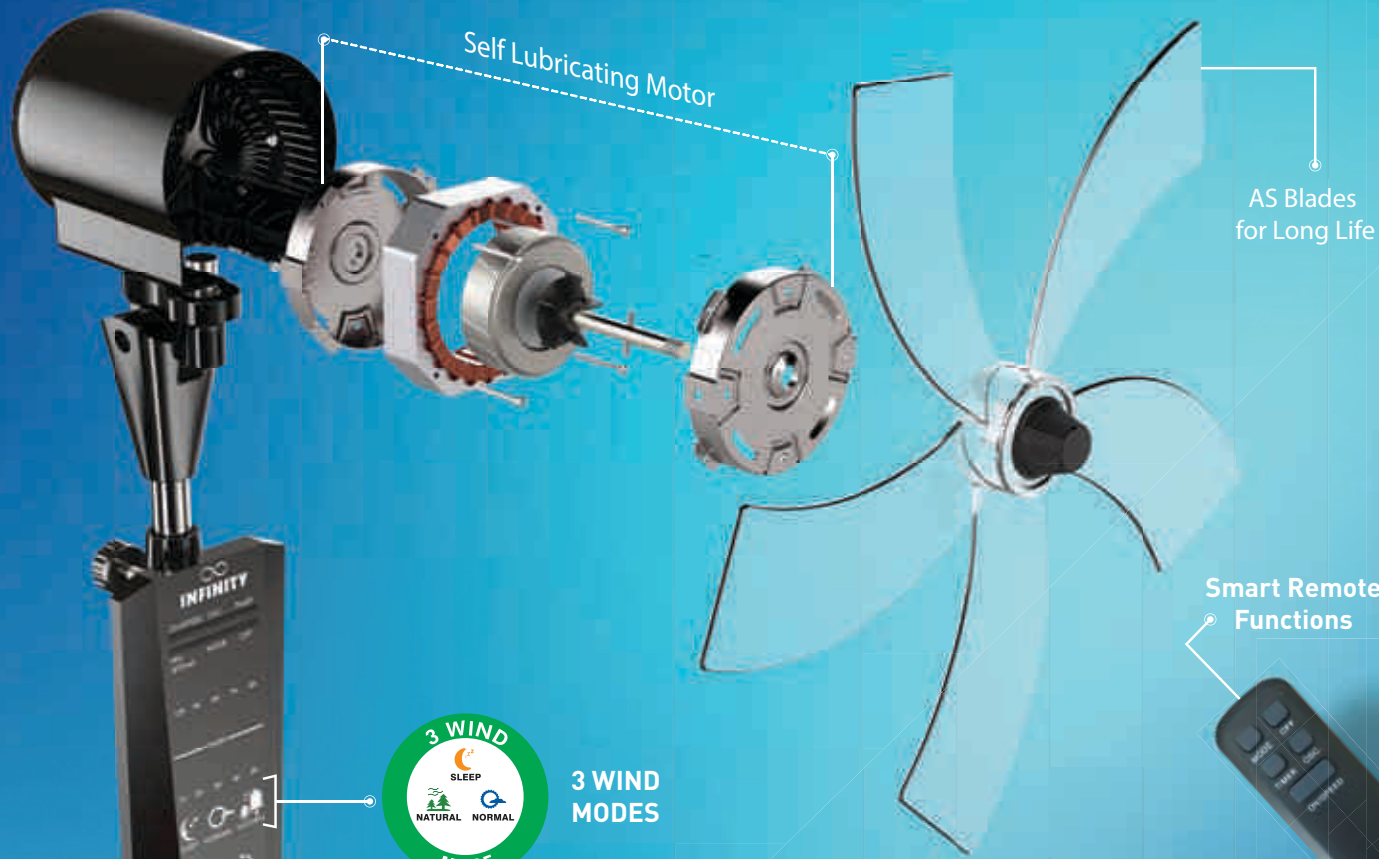

Types of Blades



Copper Winding Motor

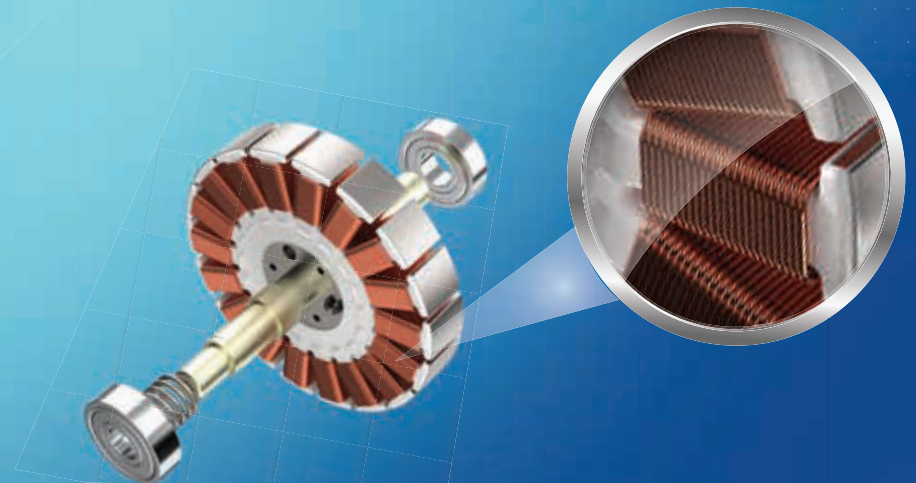
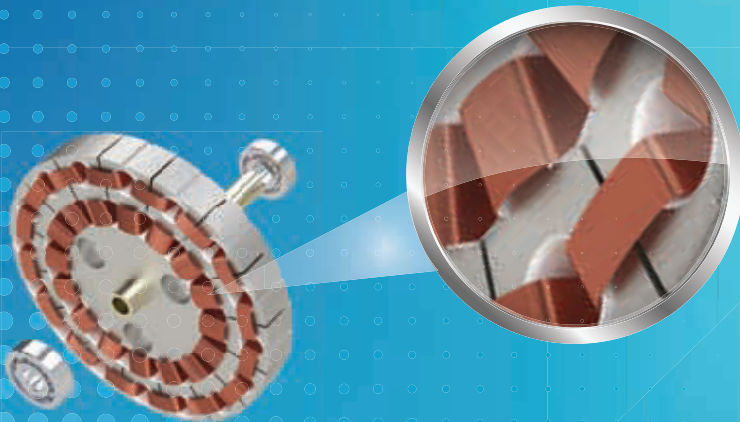



**DUST-FREE,
EASY TO CLEAN
AND CONSISTENT
FRESH LOOKS**

Sonic

Ergonomically designed sleek blades, reliable and durable motor for smooth operation and matchless design makes sonic fans the perfect one for your decorative interiors.

Model No	Sweep (mm)	Air Delivery (CMM)	Speed (RPM)	Power (Watts)
SA1200	1200mm	230	350	70



Silver White

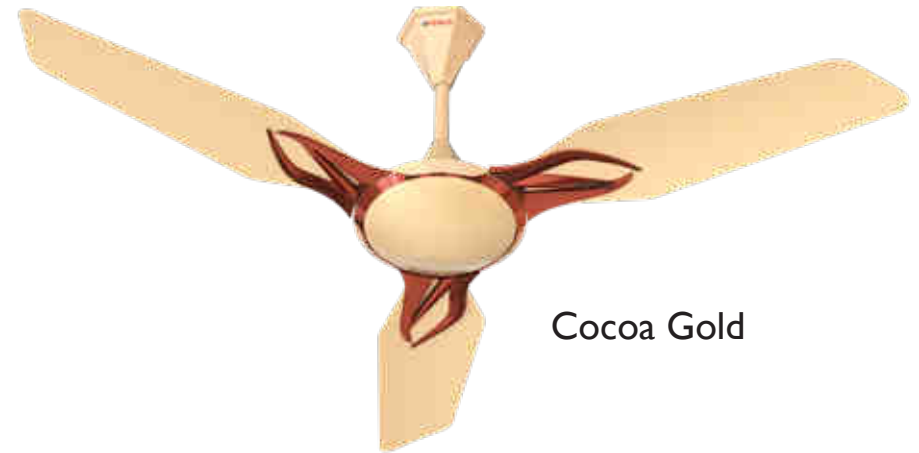

Cocoa Gold

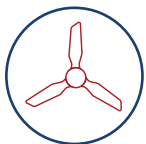

Aerodynamic & Unique Design



Higher Air Delivery



2 Years Guarantee



Dust Resistant

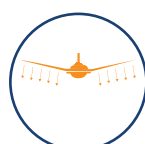

Higher Blade Angle



14 Pole Powerful Motor



Electrolytic Grade Copper Winding

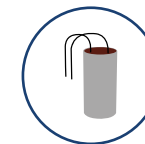

Oil Filled Capacitor



Sealed Double Ball Bearing



Halo

Halo ABS LED Fans comes with the convenience of ABS Blade and LED light easily controlled by remote. This Elegant fan comes with a regal design that gives a strong and silent breeze.

Model No	Sweep (mm)	Air Delivery (CMM)	Speed (RPM)	Power (Watts)
HPL1200	1200mm	230	300	90+15



Pearl White



Deep Wood Grain



Air Craft Propeller Design



Wider Air Delivery



15W LED Light



Rust Proof ABS Blade

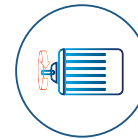

Powerful Motor



Reverse Option Warmth & Comfort



2 Years Guarantee



Novella

The stylish Novella is an elegant fan with an exquisite combination of striking design and splendid looks. This classic fan gives the experience of strong and silent breeze over a larger area powered by inclined abs blades.

Model No	Sweep (mm)	Air Delivery (CMM)	Speed (RPM)	Power (Watts)
NP1200	1200mm	240	300	75



Pearl White



Hazel Brown



Aerodynamic design blades for greater air delivery



Strong & Silent Operation



ABS Blades - Rust Proof Construction

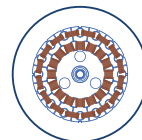

18 Pole Powerful Motor



Higher Air delivery



Striking Design, PU Coated for premium finish



2 Years Guarantee



**DUST-FREE,
EASY TO CLEAN
AND CONSISTENT
FRESH LOOKS**

Ornato

Decorative Ornato fans with non-corrossive and dust-resistant metallic finish offers elegant design with attractive color options. The stylish design with rich colours make the model a best fit for your ambient interiors

Model No	Sweep (mm)	Air Delivery (CMM)	Speed (RPM)	Power (Watts)
R1200	1200mm	220	380	80

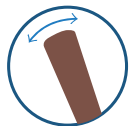

Wider Blade
High Air Circulation



100% Aluminium
Body and Blade



2 Years
Guarantee



Electrolytic Grade
Copper Winding

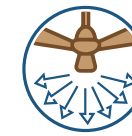

Wider
Air Delivery



Double
Ball Bearing



**DUST-FREE,
EASY TO CLEAN
AND CONSISTENT
FRESH LOOKS**



Adorna

Rust proof construction, metallic 3 layer coating, reliable and durable motor and 100% aluminium body and blades make Adorna fans the perfect choice.

Model No	Sweep (mm)	Air Delivery (CMM)	Speed (RPM)	Power (Watts)
AA1200	1200mm	220	380	75



Gold Shimmer
(Metallic)



Chestnut Brown
(Metallic)



Royal Blue
(Metallic)

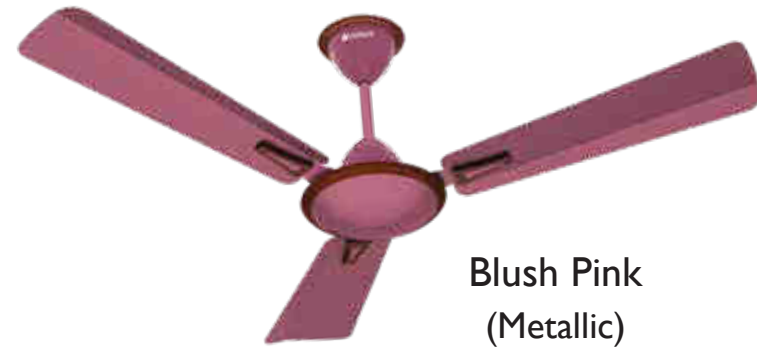

Blush Pink
(Metallic)



Metallic with
Lacquer Finish



Rust Proof
Construction



2 Years
Guarantee

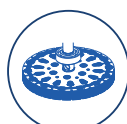

Motor Reliable
& Durable



Electrolytic Grade
Copper Winding



Double
Ball Bearing



Wider
Air Delivery



Colours Matched
with Interiors



Energy Efficient
Fans with BLDC
Technology



Vector BLDC

Vector BLDC Fans have advanced DC technology for trouble free performance and easy operation. This guarantees high speed air delivery & consumption of just 33 watts of power. Vector fans run smoothly and silently even at low voltages or when powered by Inverters.

Model No	Sweep (mm)	Air Delivery (CMM)	Speed (RPM)	Power (Watts)
VB1200	1200mm	215	350	33



Matt Brown



Energy Saving
56%



Consumes
Only 33 Watts



Hi Speed
(350 RPM)



100 % pure copper
winding motor

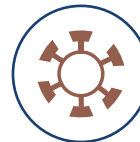

Brushless DC Motor
(BLDC) Technology



Seamless operation
even with Inverter



Sensor-less design
for more reliability



5 Years
Guarantee



Matrix Deco

Matrix deco fan from Venus is a style icon with stylish trims. It is made with 100% aluminium body and blades which makes it rust-proof and durable. It has wider blades that provide higher air delivery.

Model No	Sweep (mm)	Air Delivery (CMM)	Speed (RPM)	Power (Watts)
MD1200	1200mm	210	380	70



White



Brown



Black Gold



Stylish Design



100% Aluminium Body and Blade



Hi Speed (380 RPM)



Motor Reliable & Durable



Electrolytic Grade Copper Winding



Wider Air Delivery



Double Ball Bearing



2 Years Guarantee



Vector Hi-Speed

Vector Hi-Speed comes with a high speed of 400 RPM, a reliable and durable motor and an assortment of colours that can be matched with your interiors.



Brown



Matt Brown

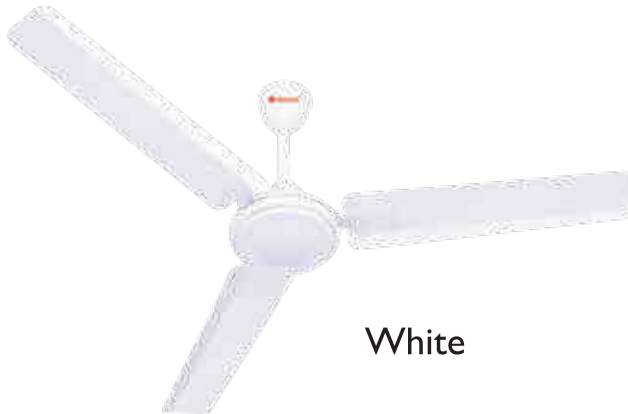

White



Ivory



Matt Brown

Model No	Sweep (mm)	Air Delivery (CMM)	Speed (RPM)	Power (Watts)
V600	600mm	110	850	65
V900	900mm	220	400	75
V1050	1050mm	220	400	75
V1200	1200mm	220	400	75
V1400	1400mm	230	300	80



Hi Speed
(400 RPM)



100% Aluminium
Body and Blade

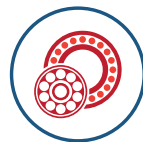

Double
Ball Bearing



Motor Reliable &
Durable



Electrolytic Grade
Copper Winding



Wider
Air Delivery



Colours Matched
with Interiors



2 Years
Guarantee

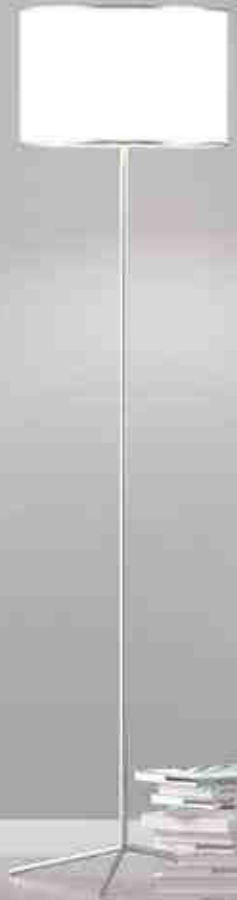

Matrix

The Matrix collection, with wider blades for high air circulation and 100% Aluminium body and blades offers maximum comfort at minimum prices

Model No	Sweep (mm)	Air Delivery (CMM)	Speed (RPM)	Power (Watts)
M900	900mm	210	380	70
M1050	1050mm	210	380	70
M1200	1200mm	210	380	70



Ivory



White



Brown

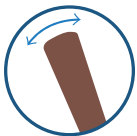

Wider Blade
High Air Circulation



100% Aluminium
Body and Blade



Electrolytic Grade
Copper Winding



Motor Reliable &
Durable



Double
Ball Bearing



Colours Matched
with Interiors



2 Years
Guarantee

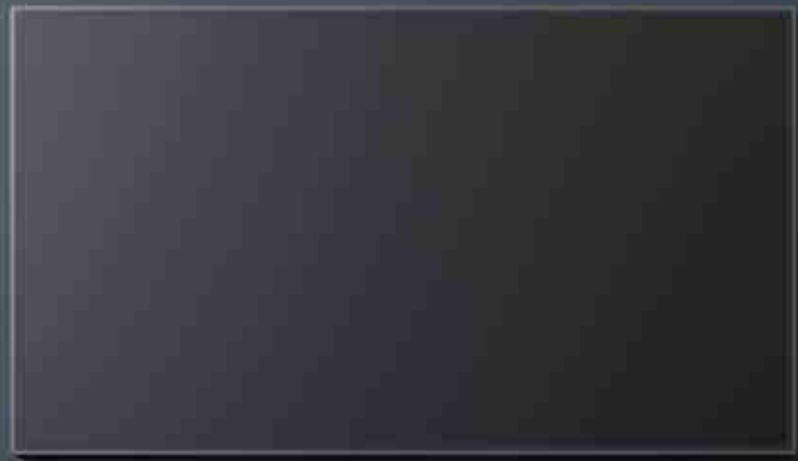

Zapper Hi-Speed

Zapper Hi-Speed fans with 400RPM offers high cool breeze in the most reliable way.

Available in an elegant design and colours to suit your Home decor.

Model No	Sweep (mm)	Air Delivery (CMM)	Speed (RPM)	Power (Watts)
ZC1200	1200mm	210	400	75



Brown



Ivory



White



Colours Matched with Interiors



Wider Air Delivery



2 Years Guarantee

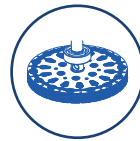

Motor Reliable & Durable



Electrolytic Grade Copper Winding

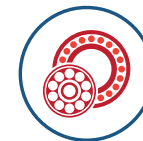

Double Ball Bearing



Hi Speed (400 RPM)



Infinity Fans

The stunning premium pedestal fan with a unique dual axis movement gives the ultimate experience of a cozy breeze. Trendy LED digital display and comfort in terms of adjusting the fan height, this explicit fan is durable with long-life AS Blade and large base for a Stable position. Overall an Elegant designed fan with Strength, comfort and convenience for a Silent breezy experience.



Infinity

Model : IDP400

- AS Blade (5 Blades) for Long Life
- 3 Speed Selection
- 3 Wind Modes: Sleep, Normal & Natural
- Self Lubricating Motor
- Safety Device for Over Heat Protection
- Timer - 1 to 10 Hours Maximum running time using remote
- Pre-set Timer - Automatic Start after specific pre-set hours
- Dual Oscillation - Up & Down, Left to Right

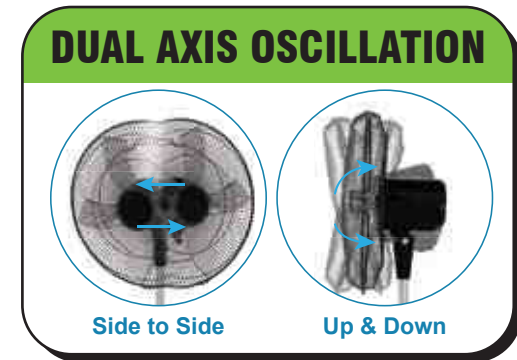

Heavy Duty Motor



3 Wind Modes



LED Digital Display



Remote Functions



Timer Digital Display



2 Years Guarantee



Farrata Fans

Farrata Fan from Venus is distinctively designed to provide Power packed performance with stylish metallic looks. Elegant design, Rust proof body and blades, Dynamically balanced metal blade makes it a completely sturdy model. Heavy weight, Extra strong motor, Attractive corrosion resistant metallic finish and Rust proof wire guards. Overall it is a stylish high speed pedestal fan



CYCLO

Model : CF500 / CFO500

- Aluminium Blade for long life
- Heavy duty extra strong motor sturdy metal construction
- 500 mm sweep • 140W Power
- 1350 RPM • 140cmm Air Delivery
- Elegant Design • 3 Speed options
- Large & heavy base for stability
- Oscillation Provided (CFO500 Model only)



CYCLO

Model : CFO400

- Rust Proof PP Blade
- Heavy duty strong motor sturdy metal construction
- 400mm sweep • 115W Power
- 2400 RPM • 95 cmm Air Delivery
- Elegant Design • 3 Speed options
- Large & heavy base for stability
- Over Heat Protection
- Oscillation Provided



TYPHOON

Model : TPF450

- Aluminium blade for long life
- 450 mm sweep • 100W Power
- 1360 RPM • 108 cmm Air Delivery
- Elegant Design
- Large & heavy base for stability
- 3 Speed options
- Oscillation Provided



Heavy Duty Motor

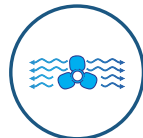

**Aluminum Blade
Higher Air Delivery**

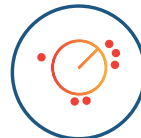

**3 Speed
Regulator**



**Rugged
Durable**



**2 Years
Guarantee**



Pedestal Fans

This range is available in regular and Hi-speed models. Light but sturdy construction. Place anywhere for a strong and cool breeze.



SWAY Hi-Speed Fan

Model : SHP400

- 400 mm sweep • 110W Power
- 2000 RPM • 85cm Air Delivery
- Elegant Design • 3 Speed options
- Strong air delivery • Jerk free
- Large & heavy base for stability
- Oscillation Provided



SWAY⁺

Model : SPF400

- 400 mm sweep • 60W Power
- 1300 RPM • 65cm Air Delivery
- Elegant Design
- Jerk free
- 3 Speed options
- Oscillation Provided
- Available colour White and Sky Blue



Hi Speed
2000 RPM



Jerk Free
Wide Oscillation



Piano Switches
for Speed Control



Elegant Design



3 speed options

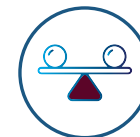

Large & Heavy
base for stability

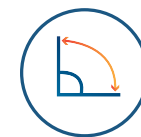

Oscillation
Provided



2 Years
Guarantee



Table Fans

Table top models for convenient operation. Available in regular and Hi-speed models. Perfect way to cool down in hot summer.

SWAY Hi-Speed Fan



Model : SHT400

- 400 mm sweep • 110W Power
- 2000 RPM • 85cm Air Delivery
- Elegant Design
- Strong air delivery
- Piano switches for speed control
- 3 Speed options
- Oscillation Provided

SWAY⁺



Model : STF-400

- 400 mm sweep • 60W Power
- 1300 RPM • 65cm Air Delivery
- Elegant Design
- 3 Speed options
- Oscillation Provided
- Available colour White and Sky Blue



Hi Speed
2000 RPM



Rust Proof
PP Blade



Piano Switches
for Speed Control



Elegant Design



3 speed options



Oscillation
Provided



2 Years
Guarantee



Wall Fans

Simple and elegant design to match your interiors. In regular and Hi-speed fans with wider air delivery.

SWAY Hi-Speed Fan



Model : SHW400

- 400 mm sweep • 110W Power
- 2000 RPM • 85cmm Air Delivery
- Elegant Design
- Strong air delivery
- 3 Speed options
- Oscillation Provided

SWAY⁺



Model : SWF400

- 400 mm sweep • 60W Power
- 1300 RPM • 65cmm Air Delivery
- Elegant Design
- 3 Speed options
- Oscillation Provided
- Available colour White and Sky Blue



Hi Speed
2000 RPM



PP Blade
Higher Air Delivery



2 Years
Guarantee



Elegant Design



3 speed options

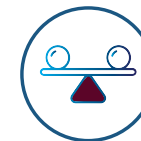

Large & Heavy
Base for stability

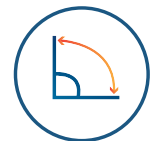

Oscillation
Provided



Exhaust Fans

Rejuvenate your kitchen and bathrooms with fresh air in minutes. Stylish and modern design to match the interiors.



Vestra / Fresh-X

Vestra exhaust fans are made from strong and rust proof ABS plastic. Louvre type design for privacy & protection from wind, rain and dust. Simple and easy to install design.



APC10 / APC15

APB15 / APB20 / APB25

FPE150 / FPE200 / FPE250

Model No	Sweep (mm)	Air Delivery (CMM)	Speed (RPM)	Power (Watts)
APC10-0-2S	100 mm	1.30	2500	12
APC15-2-2S	150 mm	2.60	1500	15
APB15-3-1S1	150 mm	4.30	1350	28
APB20-4-1S1	200 mm	8.10	1250	28
APB25-5-1S1	250 mm	12.00	1200	38
FPE150	150 mm	9.00	2400	50
FPE200	200 mm	8.60	1290	45
FPE250	250 mm	14.30	1290	45

Exair

Exair exhaust fans are great for the kitchen to exhaust the oily fumes and odour. Keeps the kitchen fresh at all times. Rugged construction ensures reliable performance for years.



EBB225/300

- High Performance Motor for Hi-Air Throw
- Bush Bearing
- Sturdy Metal Body and Blade
- Rust Proof Plastic Bird Guard

Model No	Sweep (mm)	Air Delivery (CMM)	Speed (RPM)	Power (Watts)
EBB225	225 mm	10.00	1350	46
EBB300	300 mm	20.00	1350	60



100% Copper Coil
Reliable Motor



Easy Installation
Mounting Bracket



Protection
Dust, Smell & Rain

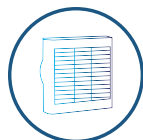

ABS Body
Long Life & Durable

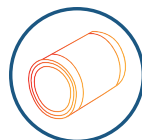

Bush Bearing

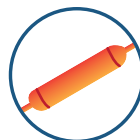

Thermal Cutout
Safety Device

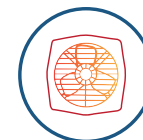

Metal Body
Long Life & Durable

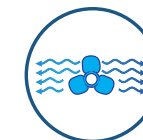

Metal Blade
Higher Air Delivery

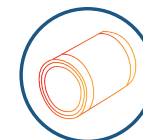

Bush Bearing



2 Year
Guarantee

Guidelines for Selection of ceiling fans

Recommended Minimum Fresh Air Supply refer the figure 1 below :

Air Space/Person	Air Supply/Person	Air Changes/Hour
3 m ³	61 m ³ /Hour	20
6 m ³	40 m ³ /Hour	6.5
9 m ³	29 m ³ /Hour	3.2
12 m ³	21 m ³ /Hour	1.8

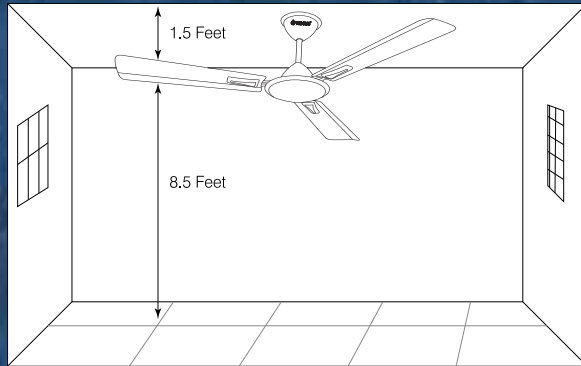

Fig. 1

For large hall, auditoriums, offices, install two or more ceiling fans with a space as specified refer the figure 2 below :

Sweep of fan	Center Distance
900 mm (36")	6 feet (1.82 mtrs. approx)
1050 mm (42")	7 feet (2.13 mtrs. approx)
1200 mm (48")	8 feet (2.43 mtrs. approx)
1400 mm (56")	10 feet (3 mtrs. approx)

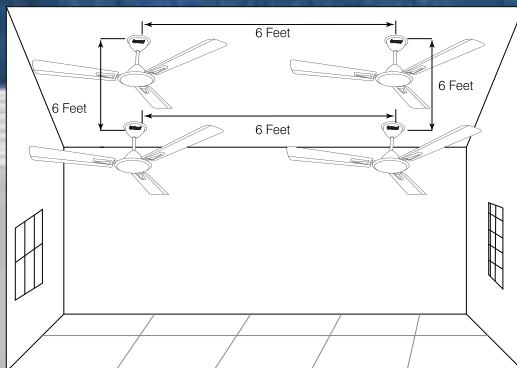
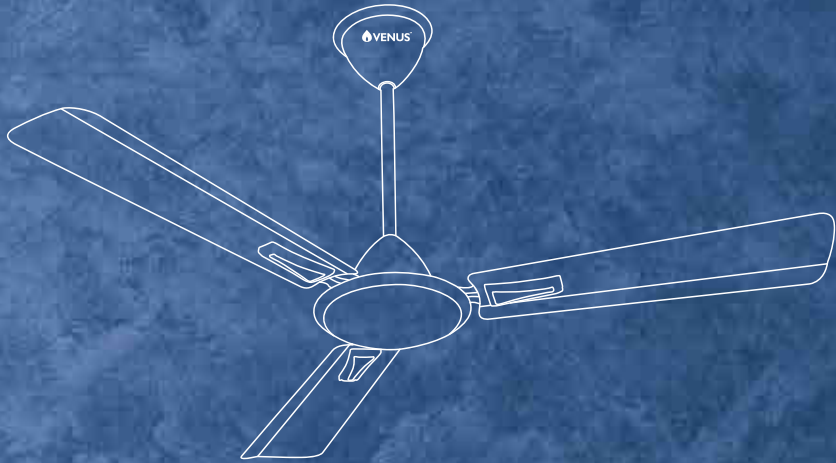

Fig. 2

General Guidelines for Ceiling Fan & Exhaust Fan		
Model	Sweep (MM)	Suitable For Room Size
Ceiling Fan	600mm (24 Inch)	For small shops, Cabins, Toilets
Ceiling Fan	900mm (36 Inch)	2.1 x 3.1 m (7 x 10 feet)
Ceiling Fan	1050mm (42 Inch)	3.1 x 3.1 m (10 x 10 feet)
Ceiling Fan	1200mm (48 Inch)	3.7 x 4.0 m (12 x 13 feet)
Ceiling Fan	1400mm (52 Inch)	4.3 x 4.9 m (14 x 16 feet)
Domestic Exhaust Fan	150mm (6 Inch)	1.8 x 1.8 x 2.7 m (6 x 6 x 9 feet)
Domestic Exhaust Fan	200mm (8 Inch)	1.8 x 1.8 x 2.7 m (6 x 6 x 9 feet)
Domestic Exhaust Fan	225mm (8.8 Inch)	2.4 x 2.4 x 2.7 m (8 x 8 x 9 feet)
Domestic Exhaust Fan	300mm (12Inch)	3.1 x 2.4 x 2.7 m (10 x 8 x 9 feet)

Selection Criteria and Recommended Minimum Fresh Air Supply Selection	
Criteria For Exhaust Fans	
Area	Air Changes Per Hour
Storage Area/Residence	1.0 - 2.0
Class rooms/Libraries	2.0 - 4.0
Assembly Hall/Labs	4.0 - 6.0
Bars/Hospital ward/Lavatories	6.0 - 8.0
Garages/Theaters/Workshops	6.0 - 10.0
Cafes/Canteens	8.0 - 12.0
Restaurants/Laundries	10.0 - 15.0
Bakeries/Canteen Kitchens	15.0 - 30.0
Engine Rooms/Boiler Houses	15.0 - 30.0
Foundries & Furnace Rooms	30.0 - 60.0



A SERVICE THAT'S FULL OF WARMTH

Venus designs its products to meet demanding national and international standards. You can be sure that this drive for quality is matched by the customer satisfaction record that our after sales service strives for. "Service within 24 hours" is the promise of our committed service personnel. With more than 250+ service centers throughout the country, prompt, economical and reliable service will reach you, wherever you are.



For service with warmth
Call Customer Care

 **08144666999**

 **09884064999**



Service in
24 hours



Genuine
spare parts



Nationwide
Service



VENUS HOME APPLIANCES (P) LTD.

CENTRAL MARKETING OFFICE: 4/993, Kamaraj Street,
Rajiv Gandhi Salai (OMR), Kottivakkam, Perungudi Post,
Chennai - 600 096. Ph: 4340 1515

Customer Care: 08144666999 | **Whatsapp:** 09884064999

Email: customercare@venushomeappliances.com

Website: www.venushomeappliances.com

