



HUNTERIDER TRADING CO., LTD.

FENCING SYSTEM

Full experiences for specialized in the line for over 20 years.

You will find various kind of Safety Mesh Fence, Gargen Fence, House Fence, Field Fence, Chain Link Fence, Hexagonal Netting Fence, Welded Mesh Fence, Grid Mesh Fence and so on.

Whether you are fencing in the perimeter of your yard, enclosing your pool, making a privacy screening for a garbage area, or creating a dog run, our fence affords strength and durability, and is an economical choice.

Garden Fence with Post



HTR No.F01



HTR No.F02



Garden Fence



Chain Link Fence



Welded Mesh

Colors



HTR No.F03



HTR No.F04



HTR No.F05



HTR No.F06



HTR No.F07

e-mail: wireproduct@163.com

1208, No.368 North Youyi Street, Shijiazhuang, Hebei, China.

Tel:0086-311-87816266 Fax:0086-311-87829302



HUNTERIDER TRADING CO., LTD.

FENCING SYSTEM

Full experiences for specialized in the line for over 20 years.

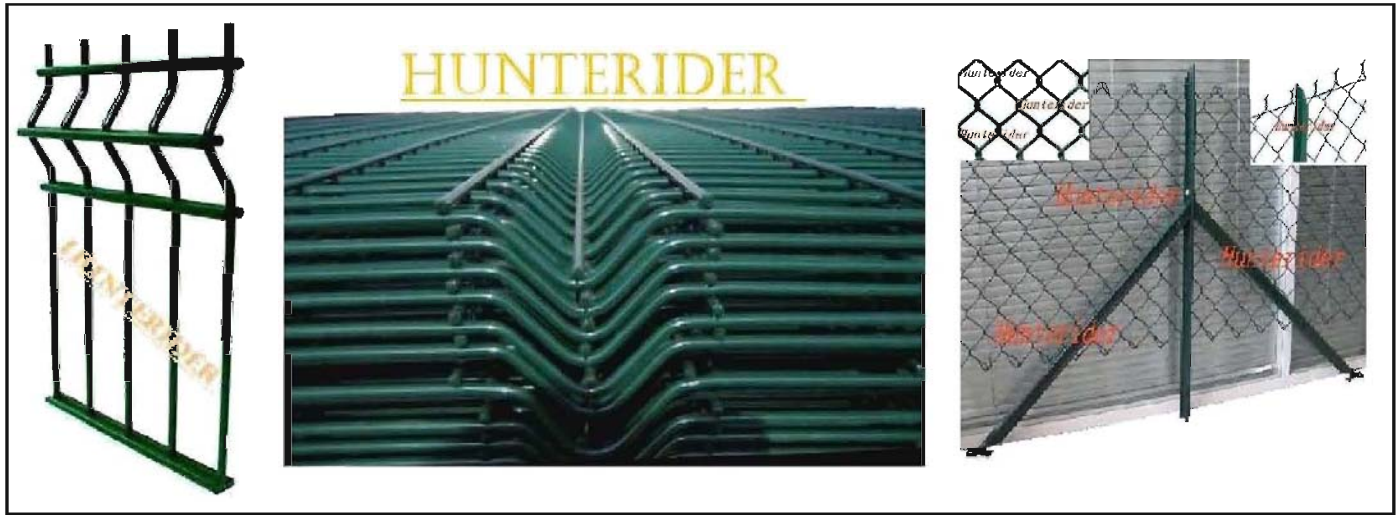

e-mail: wireproduct@163.com

1208, No. 368 North Youyi Street, Shijiazhuang, Hebei, China.

Tel: 0086-311-87816266 Fax: 0086-311-87829302



HUNTERIDER TRADING CO., LTD.

FENCING SYSTEM

Full experiences for specialized in the line for over 20 years.

Technical Details:

Technical Detail	Soft Quality		Hard Quality		High Tensile Quality	
	minimum	maximum	minimum	maximum	minimum	maximum
Diameter	0.90mm	6.50mm	0.90mm	6.50mm	0.90mm	5.00mm
Tensile Strength	350N/mm ²	550 N/mm ²	550 N/mm ²	900 N/mm ²	900 N/mm ²	1600 N/mm ²

H.D. GALVANIZED

E.GALVANIZED

PVC COATED



e-mail: wireproduct@163.com

1208, No.368 North Youyi Street, Shijiazhuang, Hebei, China.

Tel: 0086-311-87816266 Fax: 0086-311-87829302



HUNTERIDER TRADING CO., LTD.

STEEL NAILS

Full experiences for specialized in the line for over 25 years.

Surface Finishing



Bright



Electro Galvanized



Mechanical Galvanized



Hot Dip Galvanized



Color Electro Galvanized



Vinyl Coated



Black Treatment



Phosphate Coated

Shank Types



Smooth



Fluted



Twisted



Skew Fluted



Square



Screw



Ring



Barb

Head Types



Flat

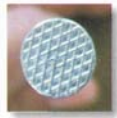

Checkered



Counter Sunk



Without Counter Sunk



Brad Head



Large Head



Umbrella Head



Rose Head



Oval Head



Cup Head



Duplex Head



Tower Head

Point Types



Diamond



Blunt



Skew



Duck Drill



Bullet

Standard Wire Gauge

Gauge	BWG	
	Inch	MM
0	0.340	8.639
1	0.300	7.620
2	0.284	7.214
3	0.259	6.579
4	0.238	6.045
5	0.220	5.588
6	0.203	5.156
7	0.180	4.572
8	0.165	4.191
9	0.148	3.759
10	0.134	3.404
11	0.120	3.048
12	0.109	2.769
13	0.095	2.413
14	0.083	2.108
15	0.072	1.829
16	0.065	1.651
17	0.058	1.473
18	0.049	1.245
19	0.042	1.067
20	0.035	0.839
21	0.032	0.813
22	0.028	0.711
23	0.025	0.635
24	0.022	0.559
25	0.020	0.508
26	0.018	0.457
27	0.016	0.406
28	0.014	0.355

Shijiazhuang Hunterider Trading Co.,Ltd.
1208,No.368 North Youyi Street,
Shijiazhuang,China.

Sales Manager: Mr.Peng
Tel: 0086-311-87816266 / 13931120515
E-mail: wireproduct@163.com



HUNTERIDER TRADING CO., LTD.

STEEL NAILS

Full experiences for specialized in the line for over 25 years.



Common Nails



Finishing Nails



Box Nails



Vinyl Coated Nails



Double Head Nails



Roofing Nails



Pallet Nails



Joist Hanger Nails



Round Cap Nails



Flooring Nails



Cup Head Drywall Nails



Furring Nails



Concrete Nails



Fence Staples



Carpet Nails



Masonry Cut



Gutter Spike



Plastic Cap Nails



Round Cap Nails

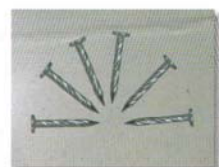

Stainless Steel Nails

Shijiazhuang Hunterider Trading Co.,Ltd.
1208,No.368 North Youyi Street,
Shijiazhuang,China.

Sales Manager: Mr.Peng
Tel: 0086-311-87816266 / 13931120515
E-mail: wireproduct@163.com



HUNTERIDER TRADING CO., LTD.

STEEL NAILS

Full experiences for specialized in the line for over 25 years.



Bright Common Nails



Electro Galvanized Common Nails



Mechanical Galvanized Common Nails



Hot Dip Galvanized Common Nails



Roofing Nails
(smooth & twisted shank)



Screw Roofing Nails
Umbrella Head



South Africa Roofing
Screw Nails



Assembled Roofing
Nails



EG Concrete Nails



Black Concrete Nails



MG Shooting Nails



Shooting Nails



Skew Point U Staple



Diamond Point U Staple



Barbed U Staple



HDG Wire U Staple



Square Boat Nails



Square Common Nails

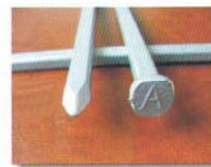

Rectangular Shank
Boat Nails



Twisted Shank Nails

Shijiazhuang Hunterider Trading Co.,Ltd.
1208,No.368 North Youyi Street,
Shijiazhuang,China.

Sales Manager: Mr.Peng
Tel: 0086-311-87816266 / 13931120515
E-mail: wireproduct@163.com



HUNTERIDER TRADING CO., LTD.

STEEL NAILS

Full experiences for specialized in the line for over 25 years.



Africa Roofing Screw Nails



Africa Roofing Screw Nails with Plastic Head



Screw Nails



环纹钉
Annular Thread Nails



Africa Copper Nails



Shoe Tacks



EG Copper Nails



EG Brass Nails



Australian Standard HDG Flat Head Nails



Australian Standard HDG Jolt Head Nails



Australian Standard HDG Floor Nails



Australian Standard HDG Clout Nails



Pallet Coil Nails



Jumbo Coil Nails



Stainless Steel Coil Nails



America Standard EG Roofing Coil Nails



Plastic Strip Nails

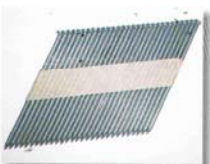

Paper Strip Nails

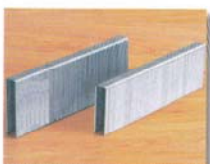

N Staple



Blunt Rivet

Shijiazhuang Hunterider Trading Co.,Ltd.
1208, No.368 North Youyi Street,
Shijiazhuang, China.

Sales Manager: Mr.Peng
Tel: 0086-311-87816266 / 13931120515
E-mail: wireproduct@163.com



HUNTERIDER TRADING CO., LTD.

STEEL NAILS

Full experiences for specialized in the line for over 25 years.

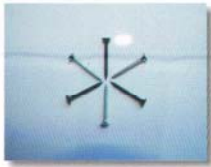

Dry Wall Screw



Chipboard Screw



Drilling Screw



Machine Screw



Black Iron Wire



Electro Galvanized Iron Wire



Hot Dip Galvanized Iron Wire



Barbed Wire



Galvanized Steel Sheet



Galvalume Steel Sheet



Color Coated Steel Sheet

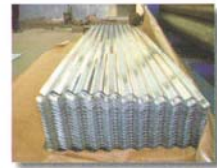

Corrugate Roofing Steel Sheet



Wire Mesh



Windows Netting



Shade Mesh



Glass Wool



Shovel



Pickaxes



Hoe



Fork

Shijiazhuang Hunterider Trading Co.,Ltd.
1208,No.368 North Youyi Street,
Shijiazhuang,China.

Sales Manager: Mr.Peng
Tel: 0086-311-87816266 / 13931120515
E-mail: wireproduct@163.com



HUNTERIDER TRADING CO., LTD.

STEEL NAILS

Full experiences for specialized in the line for over 25 years.



Plywood Pallet



Wooden Pallet



50kgs Plywood Carton



1ton Plywood Carton



30lbs Plastic Tub

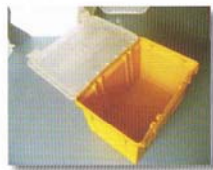

5kgs Plastic Tub



1kg Plastic Tub With Handle



100g-1kg Clam Shell



America 50lbs Carton



Common 20kgs Carton



Middle East Carton



Self-owned Brand TP Carton



5kgs Box



1kg Box



Small Box with Window



Small Color Box



Carton Inher Plastic Bag



1kg Color-Plastic Bag



Gunny Bag



Woven Fabric & Brown Paper Bag

Shijiazhuang Hunterider Trading Co.,Ltd.
1208,No.368 North Youyi Street,
Shijiazhuang,China.

Sales Manager: Mr.Peng
Tel: 0086-311-87816266 / 13931120515
E-mail: wireproduct@163.com

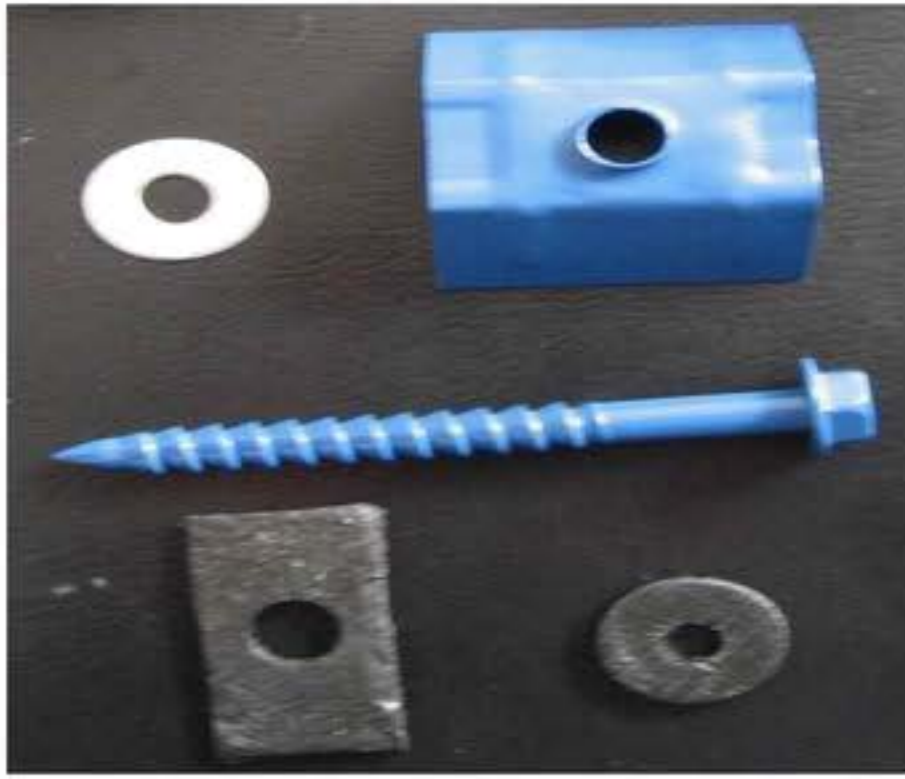

Finishing: Backing-varnish
Colour: BLUE



Finishing: Backing-varnish
Colour: RED



Finishing: Backing-varnish
Colour: GREEN



Finishing: BI-CHROMED GALV.
Colour: ORIGINAL

SIZE: 8 * 80MM
PACKING: 100SETS PER ONE BOX,
AND 8BOXES INTO ONE CARTON.



Finishing: BI-CHROMED GALV.
Colour: ORIGINAL

SIZE: 5 * 65MM
5 * 75MM
5 * 90MM
5 * 120MM
PACKING: CARTON CONTAINS 10 X 10UNITS.

SHIJIAZHUANG HUNTERIDER TRADING CO.,LTD.

1208, No.368 North Youyi Street, Shijiazhuang, China.

Tel:0086-311-87816266 Fax: 0086-311-87829302

E-Mail: wrieproduct@163.com



Contents

01	Nylon Hammer Drive Anchor, Countersunk Head
02	Nylon Hammer Drive Anchor, Cylinder Head.
03	Nylon Hammer Drive Anchor, Mushroom Head.
04	Nylon Frame Fixing, Single-Wings.
05	Nylon Frame Anchor
06	Nylon Nail-In Anchor
07	HDPE Plastic Plugs
08	Plastic Wall Plug
09	Screw Plug
10	Screw Plug
11	Knot Expansion Anchors
12	Poly-Toggles
13	Self-Drill Plasterboard Plug
14	Standard Expansion Plug
15	Sanitary Ware Screws
16	Insulation Fixing
17	Perforated Sleeve
18	Extruded Plastic Anchor
19	Plastic Packers
20	ZINC-ALLOY ANCHORS
21	Metal Anchors
22	Blister Package Series

NYLON HAMMER DRIVE ANCHOR, With Countersunk Head, Pre-Assembled.

Specification:

the article consists of a nylon plug with countersunk head and a pozidriv nail-screw, yellow zinc plated. It's suitable for fixings on concrete, bricks and other high-density material.

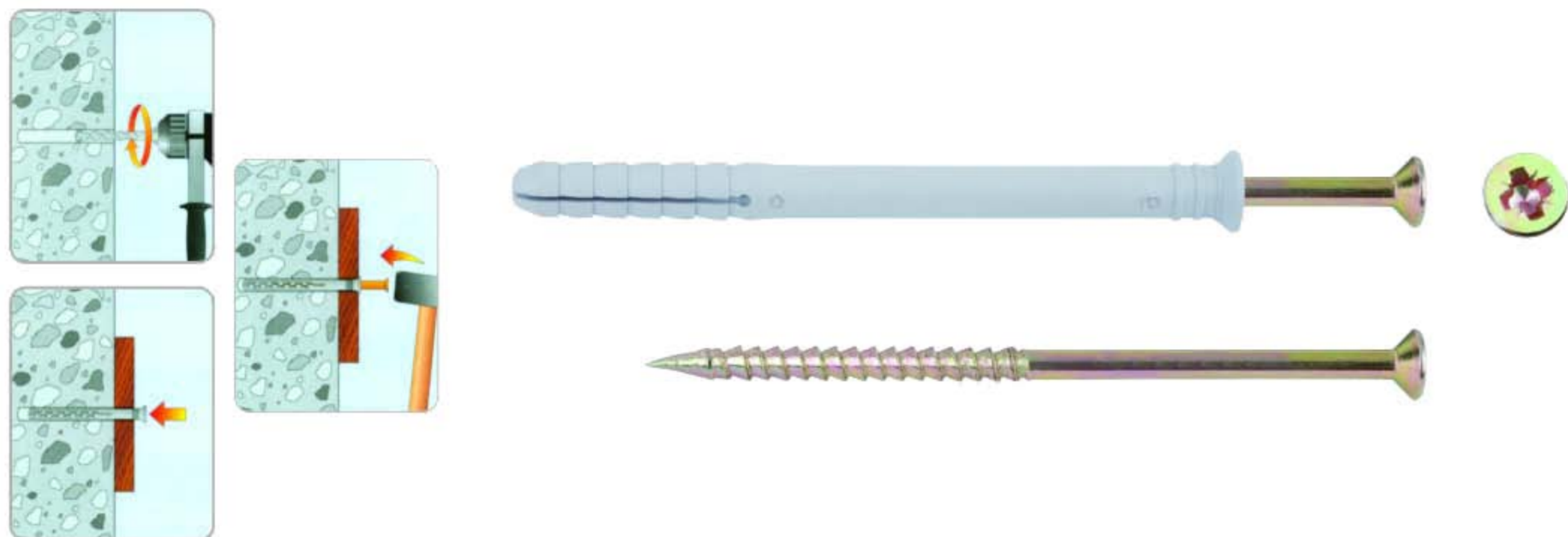

ORDER CODE	ANCHOR SIZE	NAIL SIZE	DRILL DIA. (mm)	PRACT.APPLIC MAX. (mm)	QTY PER BOX /CTN
HF0530C	5X30	3.5X35	5	5	200/2000
HF0535C	5X35	3.5X40	5	10	200/2000
HF0540C	5X40	3.5X45	5	15	200/2000
HF0545C	5X45	3.5X50	5	20	200/2000
HF0550C	5X50	3.5X55	5	25	200/2000
HF0635C	6X35	4.0X40	6	6	200/2000
HF0640C	6X40	4.0X45	6	10	200/2000
HF0650C	6X50	4.0X55	6	15	200/2000
HF0660C	6X60	4.0X65	6	30	200/2000
HF0670C	6X70	4.0X75	6	40	100/1000
HF0680C	6X80	4.0X85	6	50	100/1000
HF0850C	8X50	5.0X55	8	15	100/1000
HF0860C	8X60	5.0X65	8	20	100/1000
HF0880C	8X80	5.0X85	8	40	100/1000
HF08100C	8X100	5.0X105	8	60	100/1000
HF08115C	8X115	5.0X120	8	80	100/1000
HF08135C	8X135	5.0X140	8	90	100/1000
HF1080C	10X80	7.0X85	10	40	50/500
HF10100C	10X100	7.0X105	10	50	50/500
HF10120C	10X120	7.0X125	10	80	50/500
HF10140C	10X140	7.0X145	10	90	50/500
HF10160C	10X160	7.0X165	10	110	50/500

NYLON HAMMER DRIVE ANCHOR, With Cylinder Head, Pre-assembled.

Specification:

the article consists of a nylon plug with Cylinder head and a pozidriv nail-screw, yellow zinc plated. It's suitable for fixings on concrete, bricks and other high-density material.



ORDER CODE	ANCHOR SIZE	NAIL SIZE	DRILL DIA. (mm)	PRACT.APPLIC MAX. (mm)	QTY PER BOX /CTN
HF0670R01	6X70	3.8X73	6	40	100/2000
HF0680R01	6X80	3.8X83	6	50	100/1000
HF0850R01	8X50	4.8X53	8	15	100/1000
HF0860R01	8X60	4.8X63	8	20	100/1000
HF0880R01	8X80	4.8X83	8	40	100/1000
HF08120R01	8X120	4.8X123	8	80	100/1000
HF08135R01	8X135	4.8X138	8	90	100/1000



ORDER CODE	ANCHOR SIZE	NAIL SIZE	DRILL DIA. (mm)	PRACT.APPLIC MAX. (mm)	QTY PER BOX /CTN
HF0533R02	5X33	3.7X37	6	10	200/2000
HF0535R02	5X35	3.5X38	5	10	200/2000
HF0640R02	6X40	3.8X43	6	15	200/2000
HF0660R02	6X60	3.8X63	6	30	200/2000
HF0680R02	6X80	3.8X83	6	50	100/1000
HF0860R02	8X60	4.8X63	8	20	100/1000
HF0880R02	8X80	4.8X83	8	40	100/1000
HF08100R02	8X100	4.8X103	8	60	100/1000

**NYLON HAMMER DRIVE ANCHOR,
MUSHROOM HEAD WITH COLOURED SCREW-NAIL, "S" TYPE.**

Specification:

the article consists of a coloured pozidriv screw-nail and a coloured mushroom head anchor.
Suitable for fixings of signs,lathes and cable channels on concrete, bricks and other high-density material.



ORDER CODE	ANCHOR SIZE	NAIL SIZE	DRILL DIA. (mm)	PRACT.APPLIC MAX. (mm)	QTY PER BOX /CTN
HFS0640M	6X40	4.0X45	6	10	200/2000
HFS0660M	6X60	4.0X65	6	30	200/2000
HFS0680M	6X80	4.0X85	6	40	100/1000



ORDER CODE	ANCHOR SIZE	NAIL SIZE	DRILL DIA. (mm)	PRACT.APPLIC MAX. (mm)	QTY PER BOX /CTN
HFC0630M	6X30	4.0X35	6	5	200/2000
HFC0640M	6X40	4.0X45	6	10	200/2000
HFC0650M	6X60	4.0X65	6	30	200/2000
HFC0660M	6X80	4.0X85	6	40	100/1000

NYLON PIN

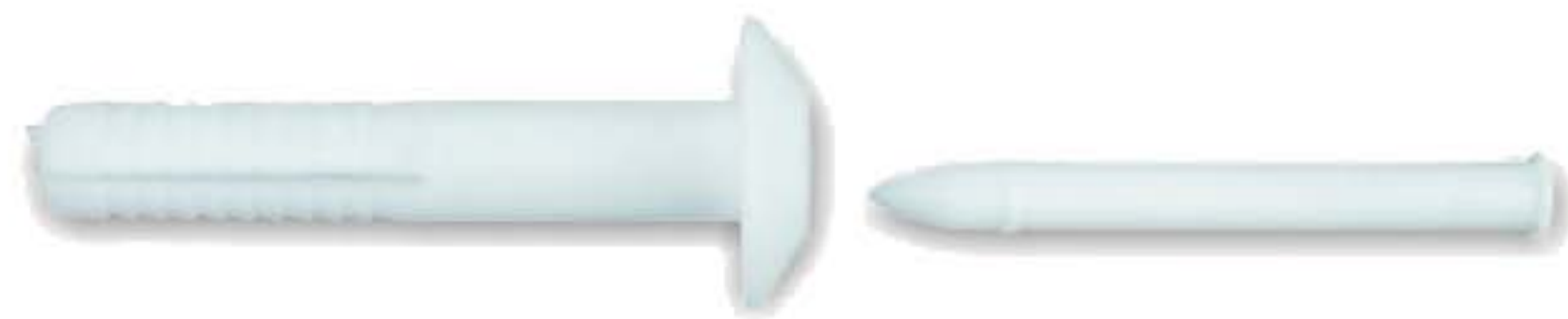

ORDER CODE	ANCHOR SIZE	NAIL SIZE	DRILL DIA. (mm)	PRACT.APPLIC MAX. (mm)	QTY PER BOX /CTN
POM1/4X3/4*M	1/4X3/4"		6	10	200/2000
POM1/4X1*M	1/4X1"		6	30	200/2000
POM1/4X1-1/2*M	1/4X1-1/2"		6	40	100/1000

**NYLON FRAME FIXING,
WITH POZIDRIV SCREW-DRILLED HEAD. SINGLE WINGS TYPE.**

Specification:

Desc: the article consists of a nylon plug with countersunk head and a pozidriv screw,yellow zinc plated with a drilled head. Suitable for fixings on concrete,bricks and other high-density material.

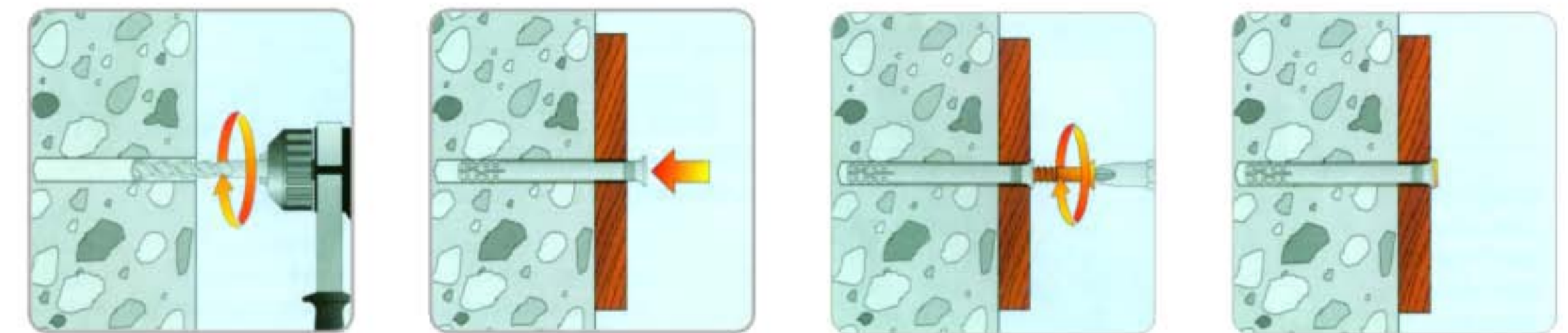

ORDER CODE	ANCHOR SIZE	NAIL SIZE	DRILL DIA. (mm)	PRACT.APPLIC MAX. (mm)	QTY PER BOX /CTN
FF05302	5X30	3.5X35	5	5	200/2000
FF06402	6X40	4.0X45	6	10	200/2000
FF06602	6X60	4.0X65	6	30	200/2000
FF06802	6X80	4.0X85	6	50	100/1000
FF08602	8X60	5.0X65	8	20	100/1000
FF08802	8X80	5.0X85	8	40	100/1000
FF081002	8X100	5.0X105	8	60	100/1000
FF081202	8X120	5.0X125	8	80	100/1000
FF10802	10X80	7.0X85	10	40	50/500
FF101002	10X100	7.0X105	10	50	50/500
FF101202	10X120	7.0X125	10	80	50/500
FF101402	10X140	7.0X145	10	90	50/500
FF101602	10X160	7.0X165	10	110	50/500

NYLON FRAME ANCHOR, SELF-DRILL SCREW

Material: Nylon 6

Color: GREY



ORDER CODE	ANCHOR SIZE	DRILL DIA. (mm)	PLUG LENGTH	SCREW DIA. (mm)	BOX QUANTITY	OUTER QUANTITY
FA10100	10X100	10	100	7X105	50	500
FA10120	10X120	10	120	7X125	50	500
FA10140	10X140	10	140	7X145	50	500
FA10160	10X160	10	160	7X165	50	500

Heavy Duty Nylon Anchor, Hexgon head Self-tapping screw.

Material: Nylon 6

Color: Red

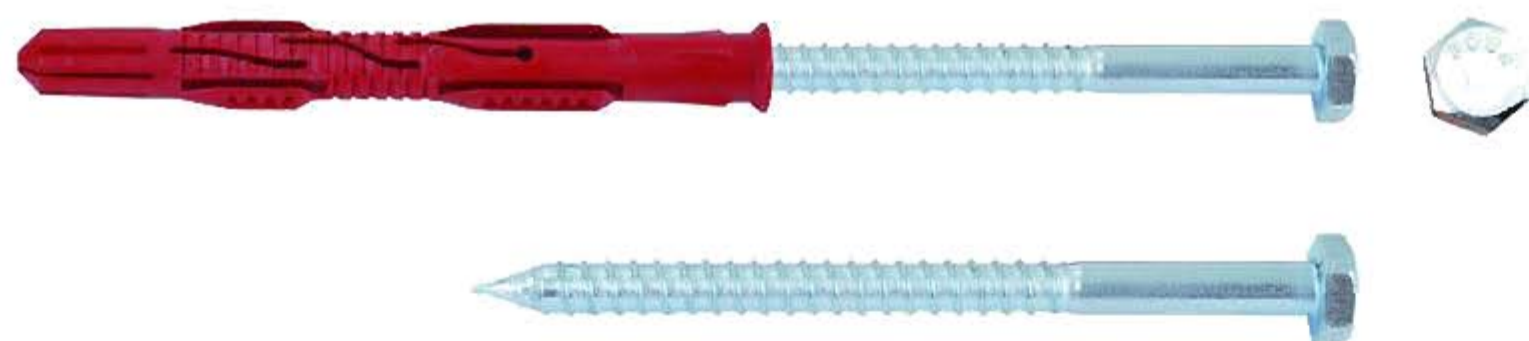

ORDER CODE	ANCHOR SIZE	DRILL DIA. (mm)	PLUG LENGTH	SCREW DIA. (mm)	BOX QUANTITY	OUTER QUANTITY
FA10100	10X100	10	100	7X105	50	500
FA10120	10X120	10	120	7X125	50	500
FA10140	10X140	10	140	7X145	50	500
FA10160	10X160	10	160	7X165	50	500

The Nylon Nailin is a nail drive anchor with a body formed from engineered plastic and drive nails available in carbon and stainless steel. The anchor can be used in concrete, block, brick or stone. The anchor is pre-assembled with either a carbon steel or stainless steel nail. This anchor is not recommended for applications overhead.

NYLON NAIL-IN ANCHOR, MUSHROOM HEAD.



ORDER CODE	ANCHOR SIZE	NAIL SIZE	DRILL DIA.	STD BOX	STD CARTON
NA0520M	5X20	3/16"X3/4"	3/16"	100	1000
NA0525M	5X25	3/16"X1"	3/16"	100	1000
NA0540M	5X40	3/16"X1 1/2"	3/16"	100	1000
NA0625M	6.5X25	1/4"X1"	1/4"	100	1000
NA0638M	6.5X38	1/4"X1 1/2"	1/4"	100	1000
NA0645M	6.5X45	1/4"X1 3/4"	1/4"	100	1000
NA0650M	6.5X50	1/4"X2"	1/4"	100	1000
NA0675M	6.5X75	1/4"X3"	1/4"	100	1000
NA06100M	6.5X100	1/4"X4"	1/4"	100	1000

NYLON NAIL-IN ANCHOR, FLATE HEAD.



ORDER CODE	ANCHOR SIZE	NAIL SIZE	DRILL DIA.	STD BOX	STD CARTON
NA0525C	5X25	3/16"X1"	3/16"	100	1000
NA0540C	5X40	3/16"X1 1/2"	3/16"	100	1000
NA0625C	6.5X25	1/4"X1"	1/4"	100	1000
NA0640C	6.5X40	1/4"X1 1/2"	1/4"	100	1000
NA0650C	6.5X50	1/4"X2"	1/4"	100	1000
NA0675C	6.5X75	1/4"X3"	1/4"	100	1000

NYLON NAIL-IN ANCHOR, ROUND HEAD.



ORDER CODE	ANCHOR SIZE	NAIL SIZE	DRILL DIA.	STD BOX	STD CARTON
NA0525R	5X25	3/16"X1"	3/16"	100	1000
NA0540R	5X40	3/16"X1 1/2"	3/16"	100	1000
NA0625R	6.5X25	1/4"X1"	1/4"	100	1000
NA0640R	6.5X40	1/4"X1 1/2"	1/4"	100	1000
NA0650R	6.5X50	1/4"X2"	1/4"	100	1000
NA0675R	6.5X75	1/4"X3"	1/4"	100	1000

HDPE PLASTIC PLUGS

TYPICAL APPLICATION: 1. For fixing of light weight loads e.g. switches, sockets, conduits trunking, skirtings and frames, junction boxes, etc.
SUITABLE FOR USE IN: Concrete, Stone/Rock, Solid Bricks&Blocks, Low Density Materials, Hollow bricks, Building Blocks, Board Materials.

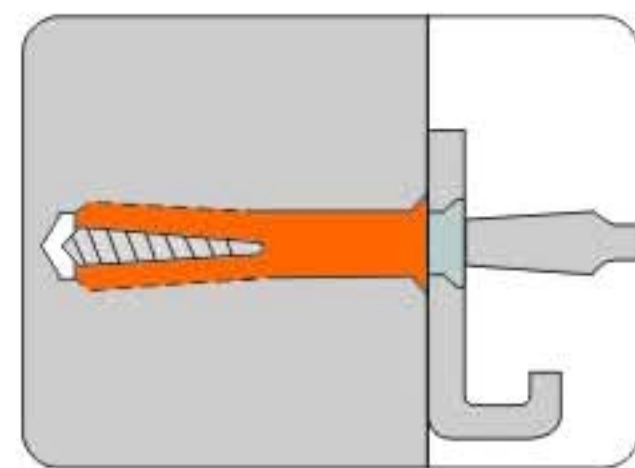
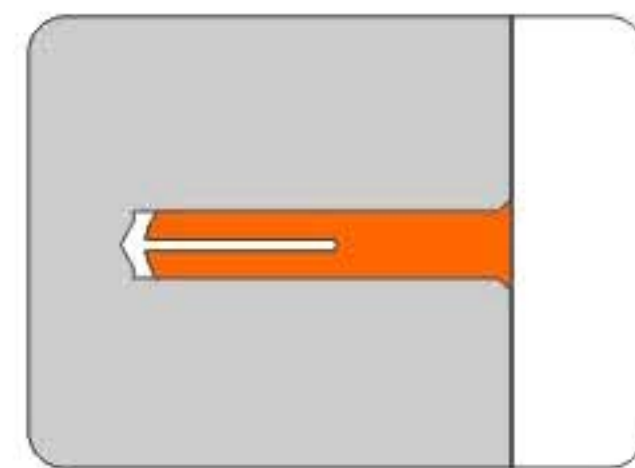
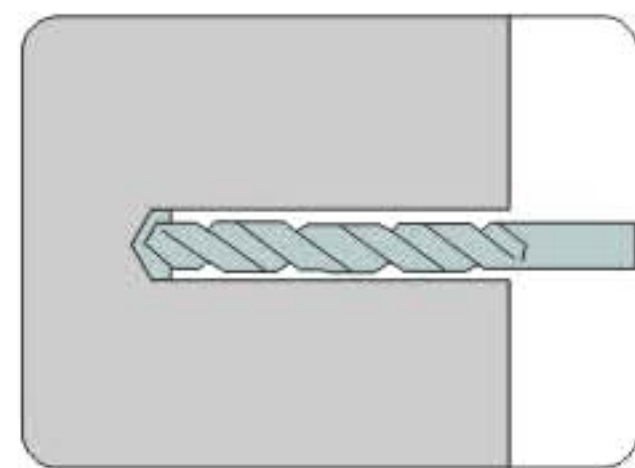

ORDER CODE	ANCHOR SIZE	DRILL DIA. (mm)	SCREW GAUGE	PLUG LENGTH	BOX QUANTITY	OUTER QUANTITY
PP5.0	5.0MM	5,5.5	4,6,8	22	100	1000
PP5.5	5.5MM	5.5,6.0	6,8,10	34	100	1000
PP7.0	7.0MM	7	8,10,12,14	40	100	1000
PP10.0	10.0MM	10	10,12,14,16	50	100	1000

PLASTIC WALL PLUGS



ORDER CODE	ANCHOR SIZE	HOLE	COLOR	PACKAGE
JTW625	6X25	6	White	400
JTG830	8X30	8	Green	250
JTB830	8X30	8	Black	400
JTG1050	10X50	10	Grey	250

SCREW PLUG

Specification:

Wall-plug of high quality nylon with screw guidance and anti-rotating-system. It can be used with several kinds of screws as woodscrews or chipboard screws. The plug works in all building materials with high densities as concrete or bricks.

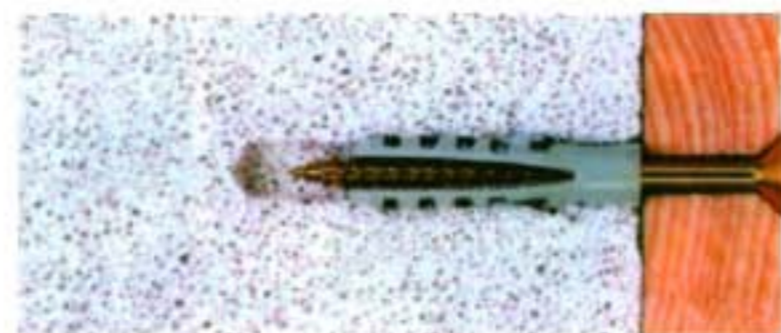

ORDER CODE	ANCHOR SIZE	DRILL DIA. (mm)	PLUG LENGTH	SCREW DIA. (mm)	BOX QUANTITY	OUTER QUANTITY
SP0420	4X20MM	4	20MM	2.0-3.0	100	10000
SP0525	5X25MM	5	25MM	2.6-4.0	100	10000
SP0630	6X30MM	6	30MM	3.5-5.0	100	10000
SP0735	7X35MM	7	35MM	4.0-5.5	100	10000
SP0840	8X40MM	8	40MM	4.5-6.0	100	10000
SP1050	10X50MM	10	50MM	6.0-8.0	50	5000
SP1260	12X60MM	12	60MM	8.0-10.0	25	2500
SP1475	14X75MM	14	75MM	10.0-12.0	25	25000
SP1680	16X80MM	16	80MM	12.0-14.0	10	1000

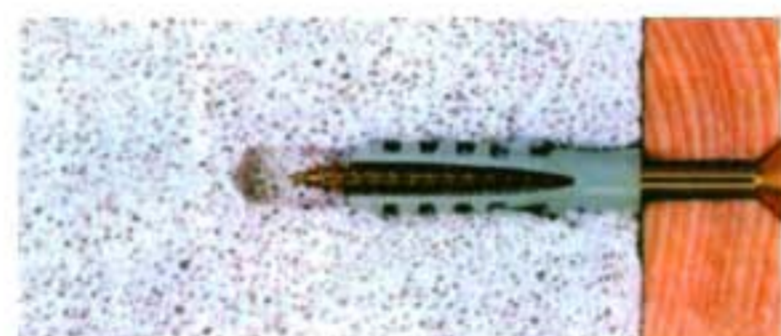

ORDER CODE	ANCHOR SIZE	DRILL DIA. (mm)	PLUG LENGTH	SCREW DIA. (mm)	BOX QUANTITY	OUTER QUANTITY
SPC0630	6X30MM	6	30MM	3.5-5.0	100	10000
SPC0735	7X35MM	7	35MM	4.0-5.5	100	10000
SPC0840	8X40MM	8	40MM	4.5-6.0	100	10000
SPC1050	10X50MM	10	50MM	6.0-8.0	50	5000
SPC1260	12X60MM	12	60MM	8.0-10.0	25	2500
SPC1475	14X75MM	14	75MM	10.0-12.0	25	25000

SCREW PLUG

Specification:

Wall-plug of high quality nylon with screw guidance and anti-rotating-system. It can be used with several kinds of screws as woodscrews or chipboard screws. The plug works in all building materials with high densities as concrete or bricks.



ORDER CODE	ANCHOR SIZE	DRILL DIA. (mm)	PLUG LENGTH	SCREW DIA. (mm)	BOX QUANTITY	OUTER QUANTITY
NP1053	10X53	10	53MM	6.0-8.0	100	10000



ORDER CODE	ANCHOR SIZE	DRILL DIA. (mm)	PLUG LENGTH	SCREW DIA. (mm)	BOX QUANTITY	OUTER QUANTITY
SN0630	6X30	6	30MM	3.5-5.0	100	10000
SN0655	6X55	6	55MM	3.5-5.0	100	10000
SN0840	8X40	8	40MM	4.5-6.0	100	10000
SN0860	8X60	8	60MM	4.5-6.0	100	10000
SN1080	10X80	10	80MM	6.0-8.0	100	10000
SN1255	12X55	12	55MM	8.0-10.0	100	10000

KNOT EXPANSION NYLON



ORDER CODE	ANCHOR SIZE	DRILL DIA. (mm)	PLUG LENGTH	SCREW DIA. (mm)	BOX QUANTITY	OUTER QUANTITY
PA0645	6X45MM	6	45MM	3.5-5.0	400	4000
PA0850	8X50MM	8	50MM	4.0-4.5	200	2000
PA1060	10X60MM	10	60MM	5.0-6.0	100	1000

Multi plug" with flange

Wall plug with flange, made of special plastic. In solid material the plug spreads; in hollow or cavity material it forms a knot and is suitable for almost all applications with woodscrews or chipboard screws. The flange prevents the plug from penetrating too deep into the drilled hole.



ORDER CODE	ANCHOR SIZE	DRILL DIA. (mm)	PLUG LENGTH	SCREW DIA. (mm)	BOX QUANTITY	OUTER QUANTITY
PA0638	6X38MM	6	38MM	3.5-5.0	400	4000
PA0851	8X51MM	8	51MM	4.0-4.5	200	2000
PA1061	10X61MM	10	61MM	5.0-6.0	100	1000

Poly-Toggles

Material: Nylon 6, Polythene
Suitable for base materials, Plasterboard.



ORDER CODE	ANCHOR SIZE	DRILL DIA. (mm)	PLUG LENGTH	SCREW DIA. (mm)	BOX QUANTITY	OUTER QUANTITY
PT3-6	3-6MM	4	46MM		400	4000
PT9-13	9-13MM	4	46MM		300	4000
PT13	13.0MM	4	46MM		200	4000
PT16-19	16-19MM	4	46MM		100	1000
PT26-29	26-29MM	4	46MM		100	1000



ORDER CODE	ANCHOR SIZE	DRILL DIA. (mm)	PLUG LENGTH	DEPTH. (mm)	BOX QUANTITY	OUTER QUANTITY
NT4-12	10X33MM	10	33MM		100	1000
NT15-19	10X40MM	10	40MM		100	1000
NT24-28	10X47MM	10	47MM		100	1000



ORDER CODE	ANCHOR SIZE	DRILL DIA. (mm)	PLUG LENGTH	DEPTH. (mm)	BOX QUANTITY	OUTER QUANTITY
NT1519	15X19	5.0	30	19	100	1000

Self-drill Plasterboard plug

Material: Nylon 66

Suitable for base materials, Plasterboard.

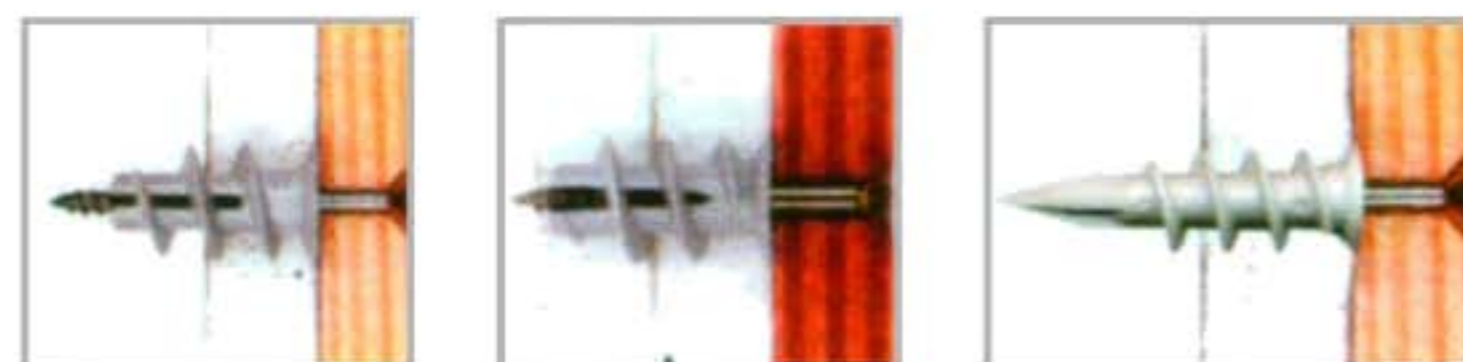

ORDER CODE	ANCHOR SIZE	DRILL DIA. (mm)	PLUG LENGTH	SCREW DIA. (mm)	BOX QUANTITY	OUTER QUANTITY
SD134001	13X40	13	40MM	4.0-5.5	100	2000
SD143201	14X32	14	32MM	4.0-5.5	100	2000
SD134203	13X42	13	42MM	4.0-5.5	100	2000
SD142803	14X28	14	28MM	4.0-5.5	100	2000
SD142300	14X23	14	23MM	4.0-5.5	100	2000

STANDARD EXPANSION PLUG

Material

Plug Sleeve: impact resistant copolymer of polypropylene PP;



ORDER CODE	ANCHOR SIZE	DRILL DIA. (mm)	PLUG LENGTH	BOX QUANTITY	OUTER QUANTITY
EP05	3/16"x3/4"	3/16"	20mm	200	2000
EP06	1/4"x1"	1/4"	25mm	200	2000
EP10	3/8"x1"	3/8"	25mm	200	2000
EP12	1/2"x1-1/2"	1/2"	38mm	100	1000



CONCIAL ANCHOR

ORDER CODE	ANCHOR SIZE	DRILL DIA. (mm)	PLUG LENGTH	BOX QUANTITY	OUTER QUANTITY
TZ20	3/16"x3/4"	5	20mm		50000
TZ22	3/16"x7/8"	5	22mm		40000
TZ25	1/4"x1"	6	25mm		20000
TZ37	5/16"x1-1/2"	8	37mm		10000



SUPER ANCHOR

ORDER CODE	ANCHOR SIZE	DRILL DIA. (mm)	PLUG LENGTH	BOX QUANTITY	OUTER QUANTITY
AS01	3/16"x1"		20mm	200	2000

Sanitary ware screw



model:JT-U1

Specifications:

- (1) Decorative cap (2pcs);
- (2) Hexagon head screw(2pcs);
- (3) Bushing (2pcs);
- (4) Dowel (2pcs)

Suitable for fixing toilets and bidet in solid centers of building materials: concrete,brick plotnotely.



model:JT-U2

Specifications:

- (1) Decorative cap (2pcs);
- (2) Nut (2pcs);
- (3) Sanitarybolt(hexagon),the diameter of 8mm,length of 100mm(2pcs);
- (4) Dowel (2pcs);

Suitable for wall mount sinks in solid centers of building material like: concrete,bricks,plastic strip with an elongated sleeve reduces the risk of damage to mounted products.

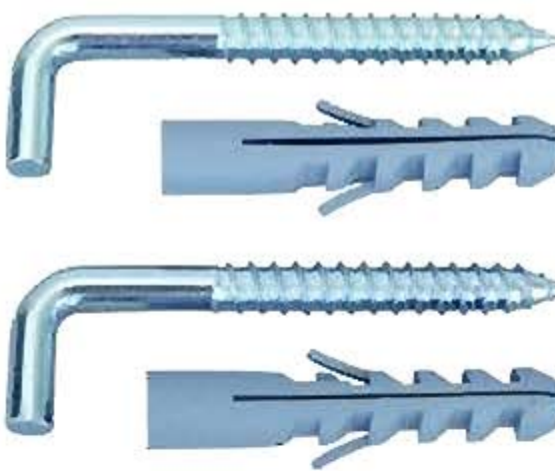

model:JT-U3

Specifications:

- (1) "L" type screw 10x100mm (2pcs);
- (2) Dowel 14x75mm (2pcs);

ORDER CODE	DOWEL SIZE	SCREW	PLUG LENGTH	SCREW DIA. (mm)	PCS/PACK
JT-U1	10X50	6X70	50	6	2SET
JT-U2	10X50	8X100	50	8	2SET
JT-U3	14X75	10X100	75	10	2SET

Insulation board plug with plastic nail

Material: polythene

Quick through-fix for insulation boards into masonry/aerated concrete/brick/concrete/stone.

For securing insulation to timber and sheet steel when used with drywall screw For use with insulation fixing for fixing soft insulation(ex:rockwool).



ORDER CODE	ANCHOR SIZE	DRILL DIA. (mm)	PLUG LENGTH	OUTER QUANTITY
IN70	10X70	10.0	70	1000
IN080	10X80	10.0	80	1000
IN090	10X90	10.0	90	1000
IN100	10X100	10.0	100	800
IN110	10X110	10.0	110	800
IN130	10X130	10.0	130	800
IN150	10X150	10.0	150	600
IN180	10X180	10.0	180	600
IN200	10X200	10.0	200	400
IN220	10X220	10.0	220	400

Insulation fixing.

Material: polythene

Solid plastic element for merchnical fixing of hardboard insulation plates on walls of concrete, bricks and other high-density material.



ORDER CODE	ANCHOR SIZE	DRILL DIA. (mm)	PLUG LENGTH	OUTER QUANTITY
IF050	8X50	8.0	50	1000
IF070	8X70	8.0	70	1000
IF090	8X90	8.0	90	1000
IF110	8X110	8.0	110	1000
IF130	8X130	8.0	130	1000

Insulation Anchor with steel nail.

Material: nylon

Anchor of nylon and spreading nail of steel.

Suitable for fixing of mineral fibre-insulation on walls of concrete and other high-and medium density material.



ORDER CODE	ANCHOR SIZE	DRILL DIA. (mm)	PLUG LENGTH	OUTER QUANTITY
IA860	8X60	8.0	60	1000PCS
IA880	8X80	8.0	80	1000PCS
IA8100	8X100	8.0	100	1000PCS
IA8120	8X120	8.0	120	1000PCS
IA8135	8X135	8.0	135	1000PCS
DISC	50mm	8.0		500PCS

Perforated sleeve for anchoring in

hollow bricks and other cavity material

Material: Nylon 6

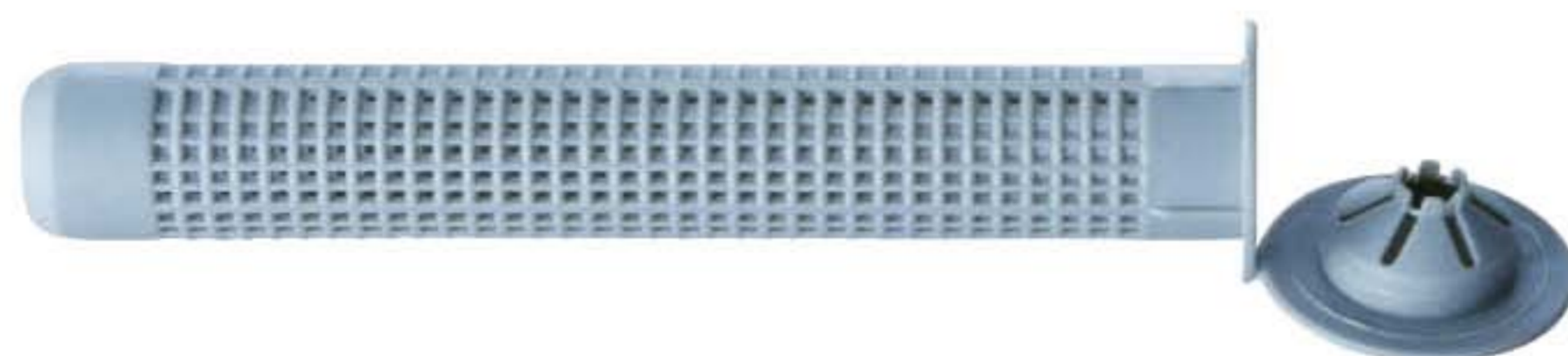

ORDER CODE	ANCHOR SIZE	DRILL DIA. (mm)	PLUG LENGTH	PACKAGE
SP1501	15X68	15	68mm	500
SP1502	15X132	15	132mm	500

Extruded plastic anchors is the original plastic anchor, this straight,fluted plug works in a variety of solid materials such as concrete,brick and stone. Easy to install,it is a flush mount anchor with color sizes for easy identification.Non-corrosive and made of flexible vinyl for durability and strength in light duty application. Vinyl plastic plugs can be used with a wide variety of standard and lag screws.



ORDER CODE	ANCHOR SIZE	COLOR	DIA. SIZE	QTY/PACK	QTY/BAG
JT535	5X35	White	5	25frames	1000pcs
JT625	6X25	Red	6	25frames	1000pcs
JT635	6X35	Red	6	25frames	1000pcs
JT650	6X50	Red	6	25frames	1000pcs
JT725	7X25	Green	7	25frames	1000pcs
JT735	7X35	Green	7	25frames	1000pcs
JT750	7X50	Green	7	25frames	1000pcs
JT825	8X25	Blue	8	25frames	1000pcs
JT835	8X35	Blue	8	25frames	1000pcs
JT850	8X50	Blue	8	25frames	1000pcs
JT1025	10X25	Orange	10	25frames	1000pcs
JT1035	10X35	Orange	10	25frames	1000pcs

FLAT GLAZING MIXED PACKERS

Plastic: Resistant to weather changes and waterproof
Colour: Each packer is colour-coded for easy identification



ORDER CODE	SIZE	THICKNESS	WIDTH. (mm)	LENGTH. (mm)	PACKAGE
FP01	28X100	1MM	28MM	100MM	1000PCS
FP02	28X100	2MM	28MM	100MM	1000PCS
FP03	28X100	3MM	28MM	100MM	1000PCS
FP04	28X100	4MM	28MM	100MM	1000PCS
FP05	28X100	5MM	28MM	100MM	1000PCS
FP06	28X100	6MM	28MM	100MM	1000PCS

PLASTIC FRAME PACKERS

Plastic: Resistant to weather changes and waterproof
Colour: Each packer is a different Colour for easy identification
Flexible Retainers: To prevent the packer falling off
Stacking: Tapered at the front and back to assist stacking
Quality: Manufactured by ISO 9001 Quality Assured Company
Ideal Use: Packing-out 100mm Partitions and Door linings



ORDER CODE	SIZE	THICKNESS	WIDTH. (mm)	LENGTH. (mm)	PACKAGE
CM01	50X100	1MM	28MM	100MM	1000PCS
CM02	50X100	2MM	28MM	100MM	1000PCS
CM03	50X100	3MM	28MM	100MM	1000PCS
CM04	50X100	4MM	28MM	100MM	1000PCS
CM05	50X100	5MM	28MM	100MM	1000PCS
CM06	50X100	6MM	28MM	100MM	1000PCS
CM07	50X100	10MM	50MM	100MM	1000PCS

ALL STEEL NAIL IN ANCHORS

Application:

The zinc nailin is a tamper-proof nail drive anchor which has a body formed from zinc-alloy, nails are available in carbon steel. The anchor can be used in concrete, block, brick or stone. This anchor is not recommended for application overhead.



ORDER CODE	ANCHOR SIZE	BOX QTY	OUTER PACKAGE
MN620	6X20	100	2000
MN630	6X30	100	2000
MN640	6X40	100	2000
MN650	6X50	100	2000
MN665	6X65	100	2000

ZINC-ALLOY SPEED ANCHORS

Application:

Fixing suspended ceiling brackets, brick ties, drywall track, insulation brackets, signage, and many more material to concrete, solid brickwork and stone.



ORDER CODE	ANCHOR SIZE	BOX QTY	OUTER PACKAGE
SA133203	13X32	100	2000
SA134203	13X42	100	2000
SA142801	14X28	100	2000
SA143201	14X32	100	2000
SA143801	14X38	100	2000
SA144201	14X42	100	2000



BLISTER PACKAGE SERIES >>



23..... PLASTIC ANCHORS



24..... MULTI PLUG



25..... WALL PLUG SETS



26..... NYLON HAMMER FIX



27..... MUSHROOM ANCHOR



28..... NYLON NAIL-IN

SCREW PLUG

ORDER CODE	ANCHOR SIZE	QTY/PCS	PCS/BOX
B-SP0525	5X25	50	200
B-SP0630	6X30	40	200
B-SP0735	7X35	30	200
B-SP0840	8X40	20	200
B-SP1050	10X50	10	200
B-SP1260	12X60	5	200



SELF-DRILLING PLASTBOARD ANCHOR

ORDER CODE	ANCHOR SIZE	QTY/PCS	PCS/BOX
B-SD1423	14X23	20	200
B-SD1342	13X42	15	200
B-SD1428	14X28	20	200
B-SD1340	13X40	15	200
B-SD1432	14X32	20	200



KNOT EXPANSION NYLON

ORDER CODE	ANCHOR SIZE	QTY/PCS	PCS/BOX
B-PA0645	6X45	30	200
B-PA0850	8X50	20	200
B-PA1060	10X60	10	200



PLASTIC TOGGLE ANCHOR

ORDER CODE	ANCHOR SIZE	QTY/PCS	PCS/BOX
B-TA3-6PP	3-6MM	20	200
B-TA9-13PP	9-13MM	20	200
B-TA13PP	13MM	15	200
B-TA16-19PP	16-19MM	15	200
B-TA26-29PP	26-29MM	10	200



NYLON TOGGLE ANCHOR

ORDER CODE	ANCHOR SIZE	QTY/PCS	PCS/BOX
B-TA1033PA	10X33	6	200
B-TA1040PA	10X40	5	200
B-TA1047PA	10X47	3	200



KNOT EXPANSION PIPE

ORDER CODE	ANCHOR SIZE	QTY/PCS	PCS/BOX
B-PP0638	6X38	30	200
B-PP0851	8X51	20	200
B-PP1061	10X61	10	200



SCREW PLUG, WITH CHIPBOARD SCREW, YZP

ORDER CODE	ANCHOR SIZE	Screw(mm)	QTY/PCS	PCS/BOX
B-SP525N	5X25	3.7X30	30	200
B-SP630N	6X30	3.8X35	25	200
B-SP735N	7X35	4.5X45	20	200
B-SP840N	8X40	4.8X50	10	200
B-SP1050N	10X50	6.5X58	6	200
B-SP1260N	12X60	8.5X70	3	200



SELF-DRILLING PLASTERBOARD ANCHOR, WITH SELF-TAPPING SCREW

ORDER CODE	ANCHOR SIZE	Screw(mm)	QTY/PCS	PCS/BOX
B-SD1423	14X23	4.2X25	20	200
B-SD1342	13X42	4.2X25	15	200
B-SD1428	14X28	4.2X25	20	200
B-SD1340	13X40	4.2X25	15	200
B-SD1432	14X32	4.2X25	20	200



KNOT EXPANSION NYLON, WITH CHIPBOARD SCREW, YZP

ORDER CODE	ANCHOR SIZE	Screw(mm)	QTY/PCS	PCS/BOX
B-PA0645N	6X45	4X50	20	200
B-PA0850N	8X50	5X60	15	200
B-PA1060N	10X60	6X80	3	200



KNOT EXPANSION PIPE, WITH CHIPBOARD SCREW, YZP

ORDER CODE	ANCHOR SIZE	Screw(mm)	QTY/PCS	PCS/BOX
B-PP0638N	6X38	4X50	20	200
B-PP0851N	8X51	5X60	15	200
B-PP1061N	10X61	6X80	3	200



NYLON HAMMER FIXING, COUNTERSUNK HEAD, YELLOWZINC PLATED NAIL SCREW

ORDER CODE	ANCHOR SIZE	Screw(mm)	QTY/PCS	PCS/BOX
B-HF0550	5X50	3.4X53	20	200
B-HF0635	6X35	3.8X37	20	200
B-HF0640	6X40	3.8X43	20	200
B-HF0650	6X50	3.8X53	15	200
B-HF0660	6X60	3.8X63	15	200
B-HF0670	6X70	3.8X73	15	200
B-HF0680	6X80	3.8X83	10	200
B-HF0850	8X50	4.8X53	10	200
B-HF0860	8X60	4.8X63	10	200
B-HF0880	8X80	4.8X83	10	200
B-HF08100	8X100	4.8X103	6	200



NYLON HAMMER FIXING, MUSHROOM HEAD, YELLOWZINC PLATED NAIL SCREW

ORDER CODE	ANCHOR SIZE	Screw(mm)	QTY/PCS	PCS/BOX
B-HF0640R	6X40	3.8X43	20	200
B-HF0660R	6X60	3.8X63	15	200
B-HF0670R	6X70	3.8X73	15	200
B-HF0680R	6X80	3.8X83	10	200
B-HF0850R	8X50	4.8X53	10	200
B-HF0860R	8X60	4.8X63	10	200
B-HF0880R	8X80	4.8X83	10	200
B-HF08100R	8X100	4.8X103	6	200



NYLON FRAME FIXING, SINGLE WINGS

ORDER CODE	ANCHOR SIZE	Screw(mm)	QTY/PCS	PCS/BOX
B-FF0530	5X30	3.5X35	30	200
B-FF0640	6X40	4.0X45	20	200
B-FF0660	6X60	4.0X65	10	200
B-FF0680	6X80	4.0X85	10	200
B-FF0860	8X60	5.0X65	5	200
B-FF0880	8X80	5.0X85	5	200
B-FF08100	8X100	5.0X105	5	200



NYLON HAMMER FIXING, MUSHROOM HEAD, YELLOW ZINC PLATED NAIL SCREW

ORDER CODE	ANCHOR SIZE	Screw(mm)	QTY/PCS	PCS/BOX
B-HFS0640	6X40	4.0X43	20	200
B-HFS0660	6X60	4.0X63	15	200
B-HFS0680	6X80	4.0X83	10	200



Sanitary ware screws

ORDER CODE	PLUG SIZE	Screw(mm)	QTY/PCS	PCS/BOX
B-JT-U1	10X50	6X70	2	200
B-JT-U2	10X50	8X100	2	200
B-JT-U3	14X75	10X120	2	200



NYLON NAIL IN ANCHOR, MUSHROOM HEAD

ORDER CODE	ANCHOR SIZE	Inch Size	QTY/PCS	PCS/BOX
B-NA520M	5X20	3/16"X3/4"	30	200
B-NA525M	5X25	3/16"X1"	20	200
B-NA540M	5X40	3/16"X1 1/2"	10	200
B-NA625M	6.5X25	1/4"X1"	20	200
B-NA640M	6.5X38	1/4"X1 1/2"	10	200
B-NA650M	6.5X50	1/4"X2"	10	200
B-NA675M	6.5X75	1/4"X3"	5	200



NYLON NAIL IN ANCHOR, CLYINDER HEAD

ORDER CODE	ANCHOR SIZE	Inch Size	QTY/PCS	PCS/BOX
B-NA520R	5X20	3/16"X3/4"	30	200
B-NA525R	5X25	3/16"X1"	20	200
B-NA540R	5X40	3/16"X1 1/2"	10	200
B-NA625R	6.5X25	1/4"X1"	20	200
B-NA640R	6.5X38	1/4"X1 1/2"	10	200
B-NA650R	6.5X50	1/4"X2"	10	200
B-NA675M	6.5X75	1/4"X3"	5	200



NYLON NAIL IN ANCHOR, COUNTERSUNK HEAD

ORDER CODE	ANCHOR SIZE	Inch Size	QTY/PCS	PCS/BOX
B-NA520C	5X20	3/16"X3/4"	30	200
B-NA525C	5X25	3/16"X1"	20	200
B-NA540C	5X40	3/16"X1 1/2"	10	200
B-NA625C	6.5X25	1/4"X1"	20	200
B-NA640C	6.5X38	1/4"X1 1/2"	10	200
B-NA650C	6.5X50	1/4"X2"	10	200
B-NA675C	6.5X75	1/4"X3"	5	200







Screw Plug, fishlike type
Model: SP0420-SP1680
Sleeve: Nylon 6.



Mid-asia Fisher Wall Plug
Model: SN860
Sleeve: PP



Standard Expansion Plug
Model: EP10
Sleeve: Polythene



Multi plug with flange.
Model: PP0851
Sleeve: PP



Knot Expansion Nylon
Model: PA1060
Sleeve: Nylon 66.



Plastic Plugs
Model: PP5.0,5.5,7.0,10.0
Sleeve: Polythene



Self-drill Plasterboard Plug,
 3-points type.
Model: SD1432
Sleeve: Nylon 66.



Self-drill Plasterboard Plug,
 one-points type.
Model: Sd1342
Sleeve: Nylon 66.



Nylon Speed Anchor
Model: Sd1423
Sleeve: Nylon 66.



Poly-Toggles
Model: PT9-13
Sleeve: PP



Nylon Toggle Anchor
Model: NT4-12
Sleeve: Nylon 6.



Conical Anchor
Model: 22mm
Sleeve: PE



Super Anchor
Model: AS
Sleeve: Polythene



Sanitary ware screws
Model: JT-U1

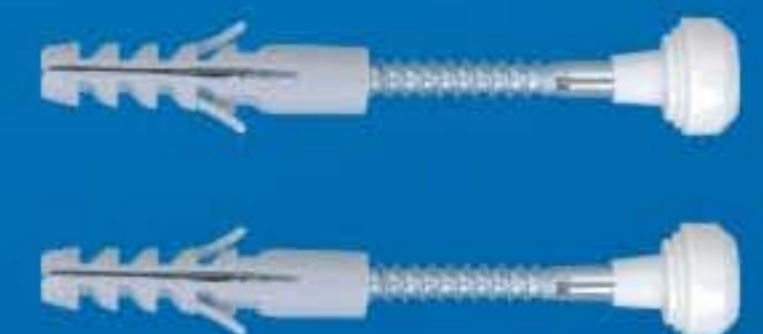

Sanitary ware screws
Model: JT-U2



Nylon Hammer Fixing,CSK head
Model: HF0530C-HF10160C
Sleeve: Nylon 6.
Screw: Blue/Yellow Zinc Plated.



Nylon Hammer Fixing,Cylinder head
Model: HF0640R01
Sleeve: Nylon 6.
Screw: Blue/Yellow Zinc Plated.



Nylon Frame Fixing, Single-wings
Model: FF05302-FF101602
Sleeve: Nylon 6.
Screw: Blue/Yellow Zinc Plated.



Nylon Hammer Drive Anchor, Cylinder Head
Model: HF0533R02
Sleeve: White nylon
Screw: Blue zinc plated.



Nylon Frame Anchor
Model: FA10100-FA10160
Sleeve: Nylon 6.
Screw: Blue/Yellow Zinc Plated.



Heavy Duty Expansion Anchor
Model: HD10100-HD10160
Sleeve: Nylon 6.
Screw: Blue/Yellow Zinc Plated.

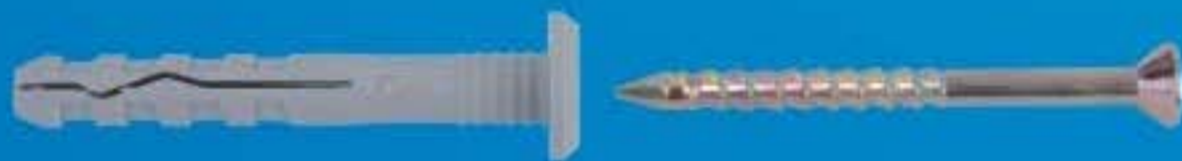

Nylon Hammer Fixing,Mushroom Head
Model: HFS0640M-HFS0680S
Sleeve: Nylon 6.
Screw: Blue/Yellow Zinc Plated.



Nylon Hammer Fixing,CSK head
Model: HFC0640M-HFC0660M
Sleeve: Nylon 6.
Screw: Blue/Yellow Zinc Plated.



Nylon Nail-In Anchor,Mush/Rnd/Csk Head
Model: NA0520-NA06100
Sleeve: Nylon 6.
Screw: Blue/Yellow Zinc Plated.



Nylon Anchor with Nylon Pins
Model: POM1/4"X1/4",1",1-1/2"
Sleeve: Nylon 6.
Screw: Nylon nail



Insulation Board Plug with Plastic Nail
Model: IN70-IN220
Sleeve: Polythene
Screw: Plastic



Insulation Fixing
Model: IF050-IF130
Sleeve: Polythene