

Product Catalogue





HUAXIN INSTRUMENT (BEIJING) CO., LTD. is a highly reputed organization dedicated to manufacturing high-quality pressure and temperature calibrator products. During considerable development, our products have already been widely used in the industries of power, chemical, petrol, metallurgy, metering, etc.

With the tenet of "Quality is Priority and The Customer is King", HUAXIN employs experienced technicians and professional sales engineers in calibration and metering field. Based on our excellent performance, we have joined in setting industry standard for product safety, operability, durability and reliability in China. Besides, our company has been accredited to ISO9001:2008 international quality management system certification since its standardized operation. Furthermore, CE approval is also smoothly passed.

HUAXIN has already achieved good accomplishment in China and has expanded to the world market depending on its constantly reliable performance. In addition, competitive price, swift delivery and good service play an important role in our company's success. Our worldwide representatives and sales network always help customers enjoy more professional calibration products and solutions.

We sincerely hope to work with worldwide customers and create a better future together!



CE



CQC



ISO9001

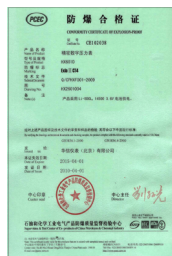

Explosion-proof



HART

CONTENT



Power Plant

Automatic pressure calibrator and the standard gauge HS602 intelligent pressure calibrator is an ideal calibration projects in power plant.



Oil&Gas Application

The portable pressure comparison pump project is an ideal calibration equipment for Oil&Gas field. Especially HS703 portable pneumatic comparison pump get many clients good feedback.

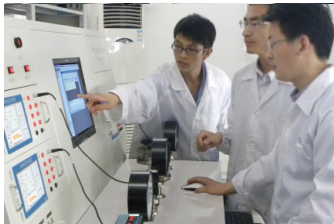

Lab Calibration

Pressure calibrator HS602 with high accuracy 0.025%F.S that is widely used as the standard gauge in calibrn lab.

● Digital Pressure Gauge 01~04

HX601/HS108

● Intelligent Pressure Calibrator 05~06

HS602

● Pressure Comparator/Comparison Pump 07~14

HS700(-0.5-0.5)bar

HS703(-0.95-40/60)bar

HS705(0-600/700)bar

HS706(0-1600/2500)bar

HS710/HS710A(0-600/700)bar

HS711/HS711A(0~600/700)bar

HS721 (-0.95~60/140)bar

HS728/HS728A(0~1000/1200/1400)bar

● Steady Servo Electrical Pressure Comparator 15~17

HS318L/HS319L(0-600)bar 5pcs output

HS316L(0-25)bar 5pcs output HS316G(0~60)bar

HS317L(0-60)bar 5pcs output

HS315(-0.95-0)bar 2pcs output

HS316(0-25)bar 3pcs output

HS318/HS319(0-600)bar 3pcs output

● Sphygomanometer Calibrator 18~19

ME01 & ME02

● Adapters and Fittings 20~22

HSPA01-M20

HSPA02-NPT

HSPA18

HSPA64

HX1039

HX2011

HX601 Digital Pressure Gauge

HX601 Digital Pressure Gauge adopts micro power components and unique software processing technology. Adopting 1pc disposable 3.6Vdc lithium battery, it could work 24 hours continuously for at least one year. With 5-digit large crystal screen, the data could be showed more clearly. Every HX601 has passed the high and lower temperature aging thus to ensure more reliable precision. The product has been used in the industries of power, chemical, petrol, metallurgy, metering, etc.

Features

- 5-digit large LCD with backlight
- Nine pressure units selectable
- Zero point, full scale calibration function
- Adopting the special software treatment technology, it is unnecessary to preheat
- RS232 communication port can communicate with PC
- Temperature compensating
- Overload alarm function
- % indication with bar graph scale for visual reference
- Stainless steel bottom connection for robustness
- Equipped with rugged aluminum alloy cover
- CE&EX approved

Specifications

- Range:(-1-0)bar,(0-700)bar,(See the pressure ranges selection sheet)
- Accuracy:±0.05%F.S,±0.1%F.S,±0.2%F.S,±0.5%F.S
- Units kPa, Pa, psi, kgf/cm²,bar,mbar,mmH₂O,mmHg,MPa
- Temperature compensating range:(-10-50)°C
- Display:5 digits with 14mm character height
- Connection:M20×1.5, 1/2"NPT,1/4"NPT,1/2"BSP,or 1/4"BSP male thread
- Dimensions:Φ93mm×41mm
- Total Height:134mm
- Weight:0.5kg



CE

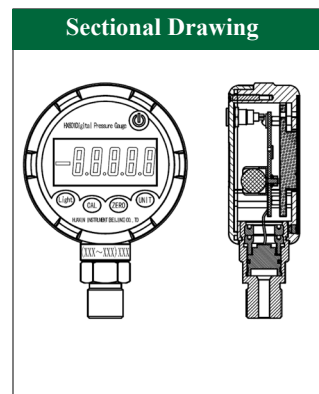

Pressure ranges selection sheet

Gauge pressure				
No.	Pressure Rang		Accuracy	Media
	(psi)	(bar)		
HX601-1	(0~10)	(0~0.7)	0.05,0.1,0.2,0.5	G
HX601-2	(0~15)	(0~1)	0.05,0.1,0.2,0.5	G
HX601-3	(0~30)	(0~2)	0.05,0.1,0.2,0.5	G,L
HX601-4	(0~60)	(0~4)	0.05,0.1,0.2,0.5	G,L
HX601-5	(0~100)	(0~7)	0.05,0.1,0.2,0.5	G,L
HX601-6	(0~200)	(0~14)	0.05,0.1,0.2,0.5	G,L
HX601-7	(0~300)	(0~20)	0.05,0.1,0.2,0.5	G,L
HX601-8	(0~500)	(0~35)	0.05,0.1,0.2,0.5	G,L
HX601-9	(0~600)	(0~40)	0.05,0.1,0.2,0.5	G,L
HX601-10	(0~1000)	(0~70)	0.05,0.1,0.2,0.5	G,L
HX601-11	(0~2000)	(0~140)	0.05,0.1,0.2,0.5	G,L
HX601-12	(0~3000)	(0~200)	0.05,0.1,0.2,0.5	G,L
HX601-13	(0~5000)	(0~350)	0.05,0.1,0.2,0.5	G,L
HX601-14	(0~6000)	(0~400)	0.05,0.1,0.2,0.5	G,L
HX601-15	(0~10000)	(0~700)	0.05,0.1,0.2,0.5	G,L

Compound pressure				
No.	Pressure Rang		Accuracy	Media
	(psi)	(bar)		
HX601-16	(-0.4~0.4)	(-0.025~0.025)	0.05,0.1,0.2,0.5	G
HX601-17	(-0.8~0.8)	(-0.05~0.05)	0.05,0.1,0.2,0.5	G
HX601-18	(-1.5~1.5)	(-0.1~0.1)	0.05,0.1,0.2,0.5	G
HX601-19	(-6~6)	(-0.4~0.4)	0.05,0.1,0.2,0.5	G
HX601-20	(-15~15)	(-1~1)	0.05,0.1,0.2,0.5	G

Note:G=Gas,L=Liquid

HS108 Digital Pressure Gauge

HS108 Digital Pressure Gauge is portable, high-accuracy test gauge. With advanced microprocessor technology and state-of-the-art silicon pressure sensors, HS108 provides an accurate, reliable and economic solution for pressure application in the industries of power, chemical, petrol, metallurgy, metering, etc. Every HS108 Digital pressure gauge pass the high and lower temperature aging, so it could assure the products more accurate and reliable.

Features

- Pressure range up to 2500bar
- High accuracy up to 0.025%F.S
- Temperature compensating
- Large, easy to read display with 6-digit resolution
- RS232 communication port can communicate with PC
- With max and min values function
- Zero point, full scale calibration function
- Nine pressure units selectable
- Equipment with rugged ABS Plastic
- 7.4Vdc rechargeable lithium battery and special charger
- Data storing function
- Large LCD with white backlight, dual readout
- CE & EX Approval

Specifications

- Range: (-1-0)bar, (0-2500)bar, (See the pressure ranges selection sheet)
- Accuracy: $\pm 0.025\%F.S$, $\pm 0.05\%F.S$, $\pm 0.1\%F.S$,
- Units kPa, Pa, psi, kgf/cm^2 , bar, mbar, mmH_2O , mmHg, MPa
- Temperature compensating range: $(-10-50)^\circ\text{C}$
- Display: 6 digits big LCD with backlight
- Connection: M20 \times 1.5, or 1/4"NPT male thread
- Dimensions: $\Phi 95\text{mm} \times 49\text{mm}$
- Total Height: 166mm
- Weight: 0.75kg

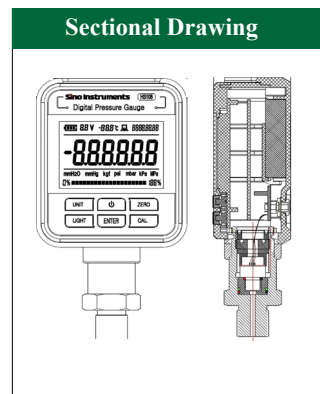

Pressure ranges selection sheet

Gauge pressure				
No.	Pressure Rang		Accuracy	Media
	(psi)	(bar)		
HS108-1	(0~10)	(0~0.7)	0.025,0.05,0.1	G
HS108-2	(0~15)	(0~1)	0.025,0.05,0.1	G
HS108-3	(0~30)	(0~2)	0.025,0.05,0.1	G,L
HS108-4	(0~60)	(0~4)	0.025,0.05,0.1	G,L
HS108-5	(0~100)	(0~7)	0.025,0.05,0.1	G,L
HS108-6	(0~200)	(0~14)	0.025,0.05,0.1	G,L
HS108-7	(0~300)	(0~20)	0.025,0.05,0.1	G,L
HS108-8	(0~500)	(0~35)	0.025,0.05,0.1	G,L
HS108-9	(0~600)	(0~40)	0.025,0.05,0.1	G,L
HS108-10	(0~1000)	(0~70)	0.025,0.05,0.1	G,L
HS108-11	(0~2000)	(0~140)	0.025,0.05,0.1	G,L
HS108-12	(0~3000)	(0~200)	0.025,0.05,0.1	G,L
HS108-13	(0~5000)	(0~350)	0.025,0.05,0.1	G,L
HS108-14	(0~6000)	(0~400)	0.025,0.05,0.1	G,L
HS108-15	(0~10000)	(0~700)	0.025,0.05,0.1	G,L
HS108-16	(0~15000)	(0~1000)	0.05,0.1	G,L
HS108-17	(0~24000)	(0~1600)	0.05,0.1	G,L
HS108-18	(0~37000)	(0~2500)	0.05,0.1	G,L

Compound pressure				
No.	Pressure Rang		Accuracy	Media
	(psi)	(bar)		
HS108-19	(-0.4~0.4)	(-0.025~0.025)	0.025,0.05,0.1	G
HS108-20	(-0.8~0.8)	(-0.05~0.05)	0.025,0.05,0.1	G
HS108-21	(-1.5~1.5)	(-0.1~0.1)	0.025,0.05,0.1	G
HS108-22	(-6~6)	(-0.4~0.4)	0.025,0.05,0.1	G
HS108-23	(-15~15)	(-1~1)	0.025,0.05,0.1	G

Note:G=Gas,L=Liquid

HS602 Intelligent Pressure Calibrator

HS602 Intelligent Pressure Calibrator has the double-line large screen with backlight. It can meet customers' requirement in the 6-digit display and 9 pressure units. It provides pressure measurement for calibrating pressure (differential pressure) transmitters, precision (general) pressure gauges and other pressure instruments. It has been used in the industries of power, chemical, petrol, metallurgy, metering, etc.

Features

- Equipped with rugged ABS plastic
- Pressure-transmitting medium including air, oil, and water
- 6-digit LCD screen with backlight
- Nine pressure units selectable
- Zero point, full scale calibration function
- 7.4Vdc rechargeable lithium battery and special charger
- Overload and short circuit protection
- Light weight, small size, easy operation
- Rapid in operation, compatible with computer software
- Support Hart Version 5
- With max and min values function
- CE&EX approved

Specifications

- Range: (-1-0)bar, (0-2500)bar, (See the pressure ranges selection sheet)
- Accuracy: $\pm 0.025\%F.S.$, $\pm 0.05\%F.S.$
Current measurement: (0-25)mA
Accuracy: $\pm(0.02\%R.D+0.005\%F.S.)$
Voltage measurement: (0-25)V
Accuracy: $\pm(0.02\%R.D+0.005\%F.S.)$
- Temperature compensating range: (-10-50)°C
- DC output: DC24V ($\leq 30mA$) Accuracy: $\pm 1\%F.S.$
- Power supply: 7.4Vdc Lithium battery power supply and special charger
- Connection: M20×1.5 or 1/4"NPT male thread
- Dimensions: $\Phi 95mm \times 49mm$.
- Total Height: 166mm
- Weight: 0.75kg

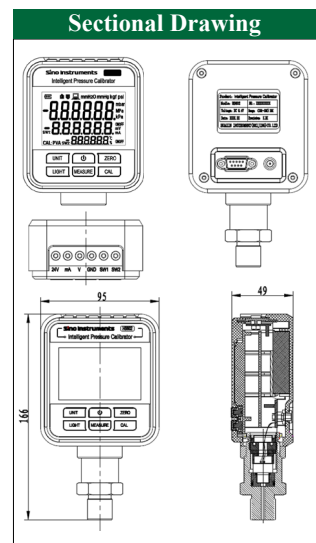

Pressure ranges selection sheet

Gauge pressure				
No.	Pressure Rang		Accuracy	Media
	(psi)	(bar)		
HS602-1	(0~10)	(0~0.7)	0.025,0.05	G
HS602-2	(0~15)	(0~1)	0.025,0.05	G
HS602-3	(0~30)	(0~2)	0.025,0.05	G,L
HS602-4	(0~60)	(0~4)	0.025,0.05	G,L
HS602-5	(0~100)	(0~7)	0.025,0.05	G,L
HS602-6	(0~200)	(0~14)	0.025,0.05	G,L
HS602-7	(0~300)	(0~20)	0.025,0.05	G,L
HS602-8	(0~500)	(0~35)	0.025,0.05	G,L
HS602-9	(0~600)	(0~40)	0.025,0.05	G,L
HS602-10	(0~1000)	(0~70)	0.025,0.05	G,L
HS602-11	(0~2000)	(0~140)	0.025,0.05	G,L
HS602-12	(0~3000)	(0~200)	0.025,0.05	G,L
HS602-13	(0~5000)	(0~350)	0.025,0.05	G,L
HS602-14	(0~6000)	(0~400)	0.025,0.05	G,L
HS602-15	(0~10000)	(0~700)	0.025,0.05	G,L
HS602-16	(0~15000)	(0~1000)	0.025,0.05	G,L
HS602-17	(0~24000)	(0~1600)	0.05	G,L
HS602-18	(0~37000)	(0~2500)	0.05	G,L

Compound pressure				
No.	Pressure Rang		Accuracy	Media
	(psi)	(bar)		
HS602-19	(-0.4~0.4)	(-0.025~0.025)	0.025,0.05	G
HS602-20	(-0.8~0.8)	(-0.05~0.05)	0.025,0.05	G
HS602-21	(-1.5~1.5)	(-0.1~0.1)	0.025,0.05	G
HS602-22	(-6~6)	(-0.4~0.4)	0.025,0.05	G
HS602-23	(-15~15)	(-1~1)	0.025,0.05	G

Note:G=Gas,L=Liquid

HS700 Micro Pressure Comparison Pump

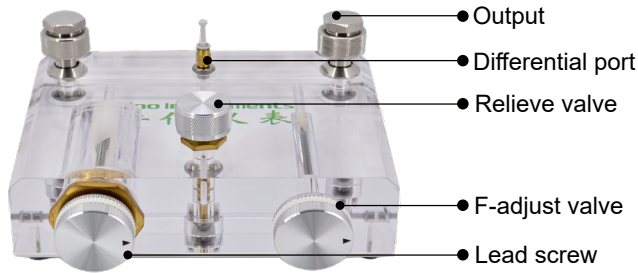

- 1.Transparent Structure
- 2.Adjust resolution 0.01mbar
- 3.Mirco Pressure Comparison

Description

HS700 Micro Pressure Comparison Pump is made from high quality and transparent plexiglass material. The operation of piston inside can be seen clearly . The whole structure is more intuitive and compact. This instrument is specially designed to generate micro pressure from vacuum to 0.5bar. The F-adjust valve could accomplish 0.01mbar pressure resolution. HS700 is a very stable Mirco Pressure Calibrator. the design of relieve valve makes the system return to zero pressure quickly.two standard pressure outputs are easy to connect gauges under test without using the wrenches. the differential port also may connect gauges under test by hose. It widely calibrates micro pressure instruments in field and laboratory.

Specifications

- **Generated pressure range:**(-0.5-0.5)bar
- **Working media:**Air
- **Adjust resolution:**0.01mbar
- **Material:**
Body:transparent plexiglass
Output part:stainless steel
Seals:Buna-N
- **Output interface connection:**
M20×1.5Female
Differential port for connect gauges under test by hose
- **Weight:**2.55kg
- **Dimensions:**260L×180W×60H(mm)



Ordering Code

Model

HS700	Model
M -M20×1.5 F N4-1/4"NPT F N4 Type,MOQ 5pcs	M-Connection

Standard delivery

Seals ring:10pcs
Test report:1copy
Manual:1copy

Optional Accessories

Model	Description
HS700-HSPA01	Fitting adaptor 10pcs
HS700-HSPA02	Fitting adaptor 10pcs
HS700-HSPA18	Fitting adaptor 18pcs
HS700-HSPA64	Fitting adaptor,hose,wrenches and so on (64pcs)
HS700-8	Digital pressure gauge HS108 or HX601 uses as master gauge
HS700-2	Pressure calibrator HS602 for calibration pressure transmitter

HS703 Pneumatic Pressure Comparison Pump

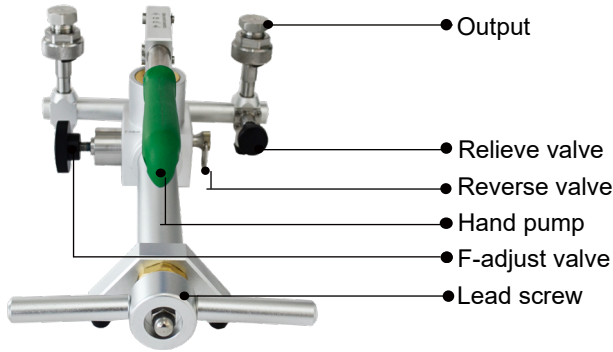

- 1. Great stability
- 2. Portable, only 2.7kg
- 3. High resolution 0.1mbar

Description

HS703 Pneumatic Pressure Comparison Pump is portable structure and designed to generate pressure from vacuum to 60bar. Built-in filter protects the pump from dirty and make maintenance easy and convenient. The F-adjust valve could accomplish 0.1mbar pressure resolution. Especially the lever lead screw design makes user operate in economize labor. the design of reverse valve makes the switch of vacuum and positive pressure more smooth. Two standard pressure outputs are easy to connect gauges under test without using the wrenches. It widely calibrates pressure instruments in field and laboratory.

Specifications

- **Generated pressure range:**
 (-0.95-16/25)bar The model HS702
 (-0.95-40/60)bar The model HS703
 (-0.95~6)bar The model HS702G
- **Working media:**Air
- **Adjust resolution:**0.1mbar
- **Material:**
 Body:Stainless steel /Aluminium
 Seals:Buna-N
- **Output interface connection:**
 M20×1.5Female
- **Weight:**2.7kg
- **Dimensions:**286L×198W×140H (mm)



Ordering Code

Model

HS702	Model
HS702G	
HS703	

M -M20×1.5 F	M-Connection
N4-1/4"NPT F	
N4Type,MOQ 5pcs	

Standard delivery

Seals ring: 10pcs
 Test report: 1copy
 Manual: 1copy

Optional Accessories

Model	Description
HS703-HSPA01	Fitting adaptor 10pcs
HS703-HSPA02	Fitting adaptor 10pcs
HS703-HSPA18	Fitting adaptor 18pcs
HS703-HSPA64	Fitting adaptor,hose,wrenches and so on (64pcs)
HS703-8	Digital pressure gauge HS108 or HX601 uses as master gauge
HS703-2	Pressure calibrator HS602 for calibration pressure transmitter

HS705 Hydraulic Pressure Comparison Pump

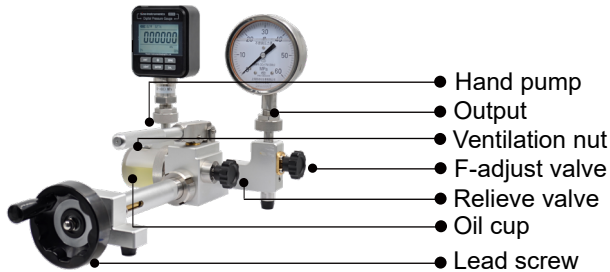

- 1. Portable only 5.2kg
- 2. Generated pressure range up to 700bar

Description

HS705 Hydraulic Pressure Comparison Pump adopts advanced stainless steel and aluminum alloy special process, compact dimension, light weight. It is portable structure and designed to generate pressure range up to 700bar. The screw pump design makes the high pressure operation more easy and save labor, the F-adjust valve adjust the exact pressure value. A detachable oil cup is easy to clean and maintenance, user could check the work medium timely from the transparent oil cover. Two standard pressure outputs are easy to connect gauges under test without using the wrenches. It widely calibrates pressure instruments in field and laboratory.

Specifications

- **Generated pressure range:** (0~600/700)bar
- **Working media:** 25[#] transformer oil,
- **Adjust resolution:** 1mbar
- **Material:** Body:Stainless Steel/Aluminium
Seals:Buna-N
- **Output interface connection:** M20×1.5Female
- **Weight:** 5.2kg
- **Dimensions:** 420L×240W×150H(mm)



Ordering Code

Model

HS705	Model
HS704(0-160/250)bar , Oil	
M -M20×1.5 F	M-Connection
N4-1/4"NPT F	
N4Type,MOQ 5pcs	

Standard delivery

- O ring:10pcs
- Test report
- Manual:1copy
- Air cell:1pc

Optional Accessories

Model	Description
HS705-HSPA01	Fitting adaptor 10pcs
HS705-HSPA02	Fitting adaptor 10pcs
HS705-HSPA18	Fitting adaptor 18pcs
HS705-HSPA64	Fitting adaptor,hose,wrenches and so on (64pcs)
HS705-8	Digital pressure gauge HS108 or HX601 uses as master gauge
HS705-2	Pressure calibrator HS602 for calibration pressure transmitter

HS706 Hydraulic High Pressure Comparison Pump

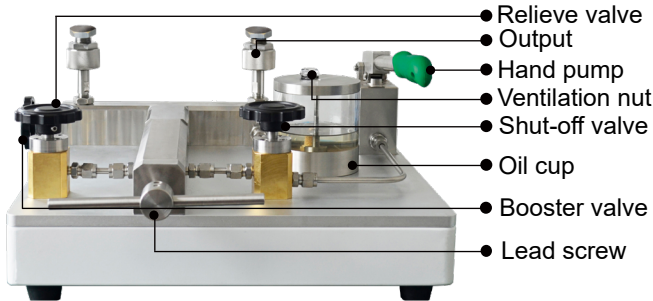

- 1. Generated pressure range up to 2500bar
- 2. Integrated operation of Booster & hand pump gets high pressure

Description

HS706 Hydraulic High Pressure Comparison Pump is generated pressure up to 2500bar to calibrate high pressure instruments against a standard gauge. It is fitted with hand pump which could quickly pressurize to the whole system; perfectly integrated operation of hand pump & Booster helps user to accomplish high pressure points calibration, closing Shut off valve during pre- pressurizing 150bar in order to get high pressure ranges. The lead screw adjusts the exact pressure values in the process. A specially designed transparent oil cup marks the balance of working medium. It widely calibrates pressure gauges in the laboratory.

Specifications

- **Generated pressure range:** (0~1600/2500)bar
- **Working media:** 25#Transformer oil
- **Adjust resolution:** 10mbar
- **Material :** Body:Stainless Steel/Aluminium
Output part:stainless steel
Seals:Buna-N
- **Output interface connection:**M20×1.5Female
- **Weight:**25kg
- **Dimensions:**570L×490W×195H (mm)
- **Package:**Plywood case



Ordering Code

Model

HS706	Model
M-M20×1.5 F	M-Connection

Standard delivery

O ring:10pcs
Test report&Manual:1copy
Air cell:1pc

Optional Accessories

Model	Description
HS706-HSPA01	Fitting adaptor 10pcs
HS706-HSPA02	Fitting adaptor 10pcs
HS706-HSPA18	Fitting adaptor 18pcs
HS706-HSPA64	Fitting adaptor,hose,wrenches and so on (64pcs)
HS706-8	Digital pressure gauge HS108 uses as master gauge
HS706-2	Pressure calibrator HS602 for calibration pressure transmitter

HS710 Hydraulic Pressure Comparison Pump

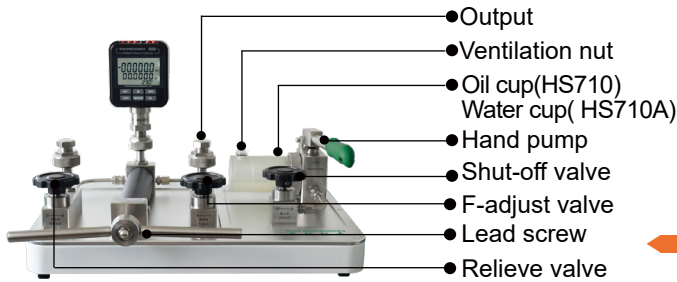

- 1. Range up to 700bar
- 2. Sliding block structure for second pump ,more save labor

Description

HS710 Hydraulic Pressure Comparison Pump adopts advanced stainless steel, with bench-top structure and designed to generate pressure range up to 700bar. The sliding block structure for screw pump design makes the high pressure operation more easy and save labor, and saves operation space without screw outside. That special F-adjust valve adjusts the exact pressure value and calibrate 2.5bar pressure instruments .The detachable Oil cup is easy to clean and maintenance, checking work medium timely from outside. 3pcs output with quick coupling makes it calibrated pressure instruments together. It widely calibrates pressure instrument in the laboratory.

Specifications

- **Generated pressure range:**(0~600/700)bar
- **Working media:**
25#transformer oil (Distilled water for model HS710A)
- **Material :**
Body:Stainless Steel/Aluminium
Seals:Buna-N
- **Adjust resolution:**1mbar
- **Output interface connection:**
M20×1.5Female
- **Weight:**14.9Kg
- **Dimensions:**430L×330W×170H (mm)



Ordering Code

Model

HS710	Model
HS710A	
M -M20×1.5 F	M-Connection
N4-1/4"NPT F	
N4Type,MOQ 5pcs	

Standard delivery

O ring:10pcs
Test report&Manual:1copy
Air cell:1pc

Optional Accessories

Model	Description
HS710-HSPA01	Fitting adaptor 10pcs
HS710-HSPA02	Fitting adaptor 10pcs
HS710-HSPA18	Fitting adaptor 18pcs
HS710-HSPA64	Fitting adaptor,hose,wrenches and so on (64pcs)
HS710-8	Digital pressure gauge HS108 or HX601 uses as master gauge
HS710-2	Pressure calibrator HS602 for calibration pressure transmitter

HS711/HS711A Hydraulic Pressure Comparison Pump

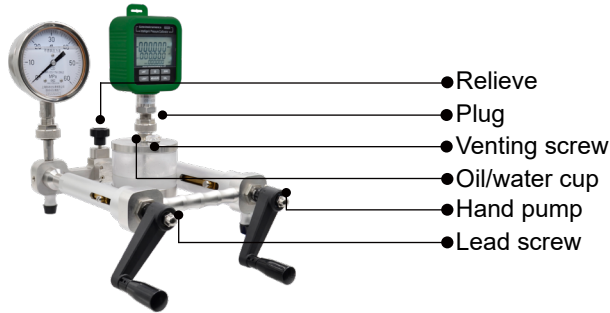

- 1. Pressure range up to 700bar
- 2. Easy increasing pressure, convenient maintenance

Description

HS711/HS711A Hydraulic comparator adopts special process with high quality aluminum alloy and pinning inside design, which make it high sealing quality, easy to clear. With the advantage of fast connection, easy generate pressure, quick pressurizing, long time keep pressure, higher accuracy, it have been widely used in Lab and Field on the pressure gauge calibration. It can be widely used in power, chemical, petrol, metallurgy, metering, military industry, etc.

Specifications

- **Model:** HS711/HS711A Hydraulic Comparator
- **Generated pressure range:** (0~600/700)bar
- **Working medium:** Oil/Distilled water
- **Adjust resolution:** 0.001bar(0.1kPa)
- **Material:** Stainless Steel/Aluminum for body; Stainless steel for outputs; Buna-N for seals
- **Output interface connection:** M20×1.5Female
- **Package:** Carrying black bag. Specialized cartons and foam wrap(optional)
- **Dimensions:** 320L×240W×140H(mm)
- **Weight:** 5.0kg



Ordering Code

Model

HS711	Model
HS711A	
M -M20×1.5 F	M-Connection
N4-1/4"NPT F	
N4Type,MOQ 5pcs	

Standard delivery

O ring: 10pcs
 Test report&Manual: 1copy
 Air cell: 1pc

Optional Accessories

Model	Description
HS711/HS711A-HSPA01	Fitting adaptor 10pcs
HS711/HS711A-HSPA02	Fitting adaptor 10pcs
HS711/HS711A-HSPA18	Fitting adaptor 18pcs
HS711/HS711A-HSPA64	Fitting adaptor, hose, wrenches and so on (64pcs)
HS711/HS711A-8	Digital pressure gauge HS108 or HX601 uses as master gauge
HS711/HS711A-2	Pressure calibrator HS602 for calibration pressure transmitter

HS721 Pneumatic pressure comparison pump

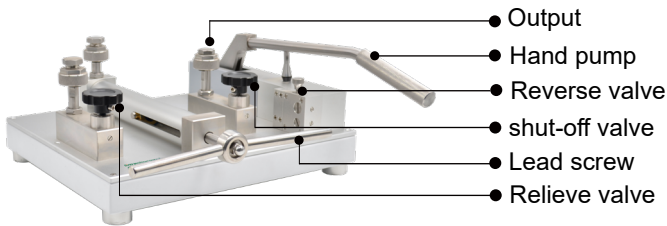

- 1. Pressure high up to 140bar
- 2. Three Outputs

Description

HS721 Pneumatic pressure comparison pump consists of hand pump, lead screw, reverse valve, relieve valve & output interface. Generate pressure from vacuum to 60bar and 140bar. It features in high sealed performance, stable pressure generating and simple operation. It is suitable in the laboratory. It can supply the pressure for calibrating pressure transmitters, precise pressure gauges, general pressure gauges and other pressure instruments.

Specifications

- Pressure range: (-0.95~60/100/140) bar
- Working Media: air
- Adjust resolution: 0.1mbar
- Material
 - Body: Stainless Steel /Aluminium
 - Seals: Buna-N
- Output Interface: M20×1.5 Female
- Dimensions: 320mm×390mm×180mm
- Weight: 14Kg



Ordering Code

Model

- HS721-1(-0.95~60) bar
- HS721-2(-0.95~100) bar
- HS721-3(-0.95~140) bar

M -M20×1.5 F M-Connection
 N4-1/4"NPT F
 N4Type, MOQ 5pcs

Standard delivery

- O ring: 10pcs
- Test report
- Manual: 1copy
- Air cell: 1pc

Optional Accessories

Model	Description
HS721-HSPA01	Fitting adaptor 10pcs
HS721-HSPA02	Fitting adaptor 10pcs
HS721-HSPA18	Fitting adaptor 18pcs
HS721-HSPA64	Fitting adaptor, hose, wrenches and so on (64pcs)
HS721-8	Digital pressure gauge HS108 or HX601 uses as master gauge
HS721-2	Pressure calibrator HS602 for calibration pressure transmitter

HS728 Hydraulic Pressure Comparison Pump

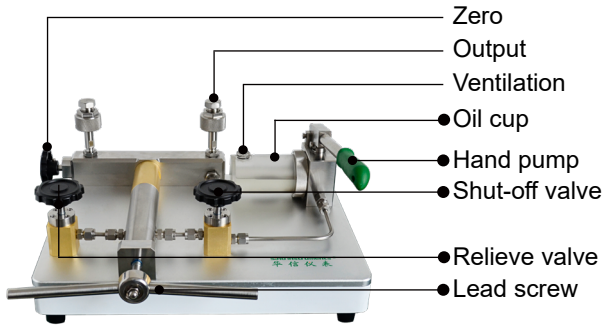

- 1.Range up to 1400bar
- 2.Fast stability ,save labor

Description

HS728 Hydraulic Pressure Comparison Pump adopts advanced stainless steel material with bench-top structure and designed to generate pressure range up to 1200bar.It is fitted with hand pump which could quickly pressurize to the whole system; perfectly integrated operation of hand pump & zero valve help user to accomplish high pressure points calibration,closing Shut off valve during pre-pressurizing 150bar in order to get high pressure ranges. the special F-adjust valve design makes the high pressure operation more easy and save labor. the detachable oil cup is easy to clean and maintenance, checking work medium timely from outside. It widely calibrates pressure instrument in the laboratory.

Specifications

- **Generated pressure range:**(0~1000/1200/1400)bar
- **Working media:**
25#transformer oil
(Distilled water for HS728A 0-1000bar)
- **Material :**
Body:Stainless Steel/Aluminium
Seals:Buna-N
- **Adjust resolution:** 1mbar
- **Output interface connection:**
M20x1.5Female
- **Weight:** 18kg
- **Dimensions:**44Lx38Wx23H(mm)



Ordering Code

Model

HS728	Model
M -M20×1.5 F	M-Connection
N4-1/4"NPT F	
N4Type,MOQ 5pcs	

Standard delivery

O ring: 10pcs
Test report&Manual: 1copy
Air cell: 1pc

Optional Accessories

Model	Description
HS728-HSPA01	Fitting adaptor 10pcs
HS728-HSPA02	Fitting adaptor 10pcs
HS728-HSPA18	Fitting adaptor 18pcs
HS728-HSPA64	Fitting adaptor,hose,wrenches and so on (64pcs)
HS728-8	Digital pressure gauge HS108 or HX601 uses as master gauge
HS728-2	Pressure calibrator HS602 for calibration pressure transmitter

HS318L Steady Servo Electrical Pressure Comparator

- *First model ,unique design*
- *Steady & Servo control pressure*
- *Five pieces outputs ,make calibration more efficient*

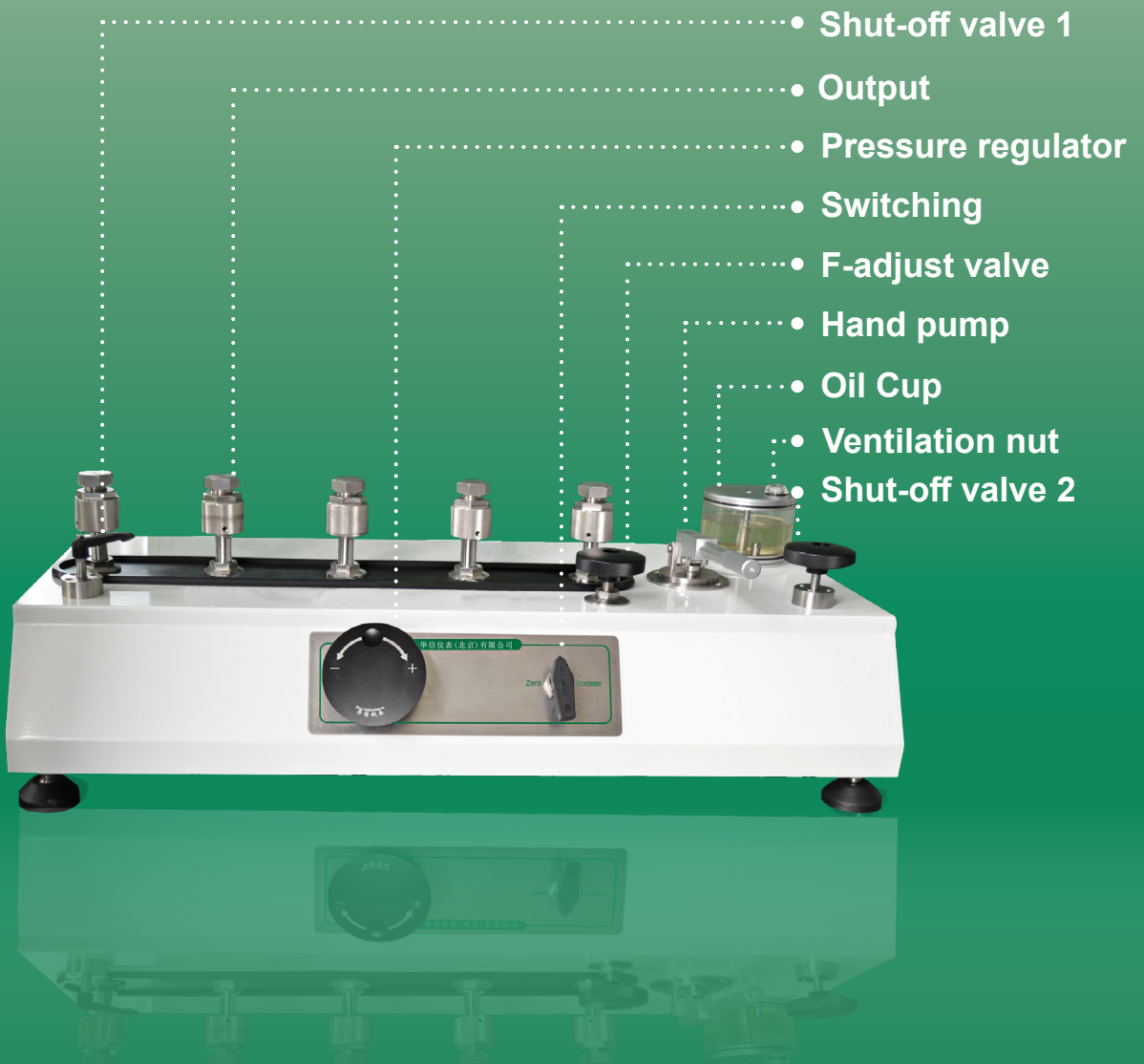

Description



HS318L Steady Servo Electrical Pressure Comparator adopts gas-liquid push or gas-gas push principle. The extra air sources give active power to pre-pressure for the whole calibrating system, perfectly instead of the heavy and complex hand work operation. Servo control pressure and dynamic equilibrium design that make the pressure values very exact and stability. Pressure regulator adjust the exact pressure value with the min adjust resolution 1kPa. Very save labor, only a finger can pressurize to full scale. 5pcs pressure output interface with stainless steel material, that can calibrate four pressure gauges once time. The quick coupling is easy to install pressure instrument without using the wrenches.

This instrument is easy to operate and very rapidly generate the required testing pressure, providing precise pressure control, only needs less than 5s to stabilize the pressure. Following the points above mentioned, its main features is in saving both effort and time, which is very suitable to do heavy & repeat calibration.

Specifications

- **Generated pressure range:**
 - (0~600)bar, The model HS318L&HS319L
 - (0~25)bar, The model HS316L
 - (0~60)bar, The model HS317L&HS316G
- **Working medium:**
 - 25# transformer oil for HS318L/HS317L
 - Air for HS316L/HS316G
 - Distilled water for HS317L&HS319L
- **Stability speed:**
 - Within 5S each point
- **Material:**
 - Steel for main body
 - Body: Output part: stainless steel
 - Seals: Buna-N
- **Output interface connection:**
 - M2.0×1.5(Female)5pcs
- **Net weight:**
 - HS319L&HS318L: 26.5kg
 - HS317L&HS316L: 24kg
- **Dimensions:**
 - HS319L&HS318L: 730L×350W×250H (mm)
 - HS317L & HS316L: 850L×320W×250H (mm)
- **Package:** Plywood case



- ①  5pcs output interface, make the calibration more efficient
- ②  Easy to operate and rapidly generate the required pressure by only a finger
- ③  Transparent oil cup, that easy to check the work media



Electrical Pressure Comparator Series

This series adopts gas-liquid push or gas-gas push principle. the extra air sources give active power to pre-pressure for the whole calibrating system, perfectly instead of the heavy and complex hand work operation.

This instrument is easy to operate and very rapidly generate the required testing pressure, providing precise pressure control, only needs less than 5s to stabilize the pressure. Following the points above mentioned, It's main features is in saving both effort and time, which is very suitable to do heavy&repeat calibration works.

Advantage

- Steady Servo Control
- Fast stability less than 5s
- Only 1-2 mins realize the full scale calibration
- Easy to operation & save labor

Specifications

Picture			
Model	HS315	HS316	HS318&HS319
Pressure	(-0.95~0)bar	(0~25)bar	(0~600)bar
Media	Air	Air	25# transformer oil (water for HS319)
Working Environment	Lab	Lab	Lab
Output interface	M20×1.5(Female) 2pcs	M20×1.5(Female) 3pcs	M20×1.5(Female) 3pcs
Size(LxWxH)	305L×300W×165H (mm)	450L×350W×135H (mm)	500L×350W×135H (mm)
Weight	4.9kg	14kg	16kg
Features	Fast stability Labor saving Easy to Operation	Fast stability Labor saving Easy to Operation	Fast stability Labor saving Easy to Operation

Ordering Code

Model

HS315	Model
HS316 HS318 HS319	
HS316L HS316G HS317L HS318L HS319L	

M-Connection

M-M20×1.5 F

Standard delivery

Seals ring:10pcs Test report:1copy Manual:1copy

Optional Accessories

Model	Description
HSE-HSPA01	Fitting adaptor 10pcs
HSE-HSPA02	Fitting adaptor 10pcs
HSE-HSPA18	Fitting adaptor 18pcs
HSE-HSPA64	Fitting adaptor,hose,wrenches and so on(64pcs)
HSE-8	Digital pressure gauge HS108 or HX601 uses as master gauge
HSE-2	Pressure calibrator HS602 for calibration pressure transmitter

ME01 Sphygmomanometer Calibrator

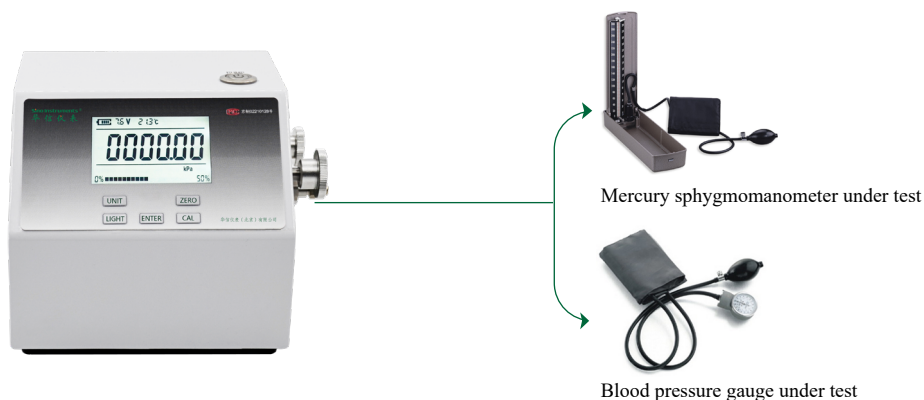

Description

ME01 Sphygmomanometer Calibrator integrates pressure generating and measuring into one. Microprocessor in ME01 will be able to make automatic adjustment and compensation of non-linear and zero drift. The built-in high-stability pressure-transducer and 24-bit A/D converter will insure the precision and the stability of the unit. It is used for calibrating sphygmomanometer in metrology body, hospital, the University lab, sphygmomanometer manufacturers and so on.

Specifications

- **Generated pressure range:**
(0~40)kPa / (0-300mmHg)
- **Accuracy:**0.05%F.S
- **Working media:**Air
- Double lines large LCD
- Pressure unit kPa and mmHg display simultaneously
- Built-in pressure transducers, manual calibrate without the hardware adjustment
- Power adaptor 9Vdc, built-in rechargeable lithium battery
- **Dimensions:**145L×160W×130H (mm)
- **Weight:**2.2kg

Ordering Code

Model

ME01	Model
ME02	

Features

- Built-in automatic pressure source, easy to pressurization
- With F-adjust function get the exact pressure value
- The pressure value could be regulated randomly
- Pressure unit kPa & mmHg display simultaneously
- Calibrating (0-40)kPa pressure gauge
- Large LCD with back light
- Acquisition speed fast
- Simple operation, save labor
- Compact structure
- Light weight

Accessories

ME02	Pen for touch screen	Type hose
	500ML Air capacity	100ML Air capacity
	3pcs Special joints for OMRON electrical sphygmomanometer	
ME02	Sphygmomanometer hose	
	Power adaptor	
	Pyramid joint φ6	
ME01	Manual & test report	

ME02 Non-invasive Sphygmomanometer Calibrator



Advantage

- Portable, only 4kg
- 7 inch large LCD
- 18 group application mode

Description

ME02 is used for simulating human body blood pressure with output signal stability and good repeatability. It provides static pressure output & measuring, automatic leaking testing, dynamic blood pressure simulating function. that is used for calibrating sphygmomanometer in metrology body, hospital, the University lab, Sphygmomanometer manufacturers and so on.



Static Pressure Output

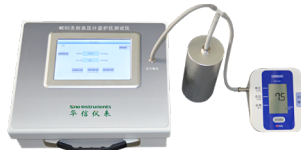

Dynamic Blood Pressure Simulating

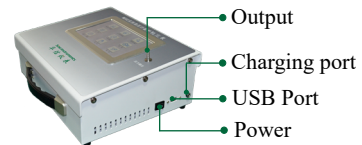

Features

- Portable, easy to use in field
- With rechargeable battery
- Automatically pressurized and depressurized
- 7 inch touch-screen, external wireless mouse
- Adopt import pressure transducer and pressure components
- Reminding when the pressure value approaching
- Stability time set 0-60s selectable
- Voice is less than 40 decibel
- Build in adults/newborn cuff
- 18 group application, only set once time for permanent store
- **Dimensions:** 300L×250W×110H (mm)
- **Weight:** 4kg

Specifications

- **Generated pressure:** (0-60)kPa / (0-450)mmHg
- **Control pressure stability:** 0.05%F.S
- **Pressure measuring:** (0-60)kPa / (0-450)mmHg
- **Accuracy:** ±0.1%F.S
- **Resolution:** 0.01kPa (0.1mmHg)
- **Adults simulating range:**
Systolic pressure (50-255)mmHg / (6.7-34)kPa
Diastolic pressure (30-195)mmHg / (4.0-26)kPa
- **Newborn simulating range:**
Systolic pressure (30-120)mmHg / (4.0-16)kPa
Diastolic pressure (10-100)mmHg / (1.3-13.3)kPa
- **Blood pressure value repeatability:**
less than (2mmHg)
- **Heart rate range:** (30-250) times/mins
- **Heart rate accuracy:** ±1%R.D
- **Pulse value:** (0.1-2.4)ml

Thread adapters

HSPA01-M20(Hand-tight quick connectors)

M20×1.5 Male to various hand-tight quick connectors(10pcs,case included)

Model	Description	Max Pressure
HSPAM20M-2NPTF	Adapters M20×1.5 Male to 1/2NPT Female	15,000psi
HSPAM20M-4NPTF	Adapters M20×1.5 Male to 1/4NPT Female	15,000psi
HSPAM20M-8NPTF	Adapters M20×1.5 Male to 1/8NPT Female	15,000psi
HSPAM20M-3NPTF	Adapters M20×1.5 Male to 3/8NPT Female	15,000psi
HSPAM20M-2BSPF	Adapters M20×1.5 Male to 1/2BSP Female	15,000psi
HSPAM20M-4BSPF	Adapters M20×1.5 Male to 1/4BSP Female	15,000psi
HSPAM20M-8BSPF	Adapters M20×1.5 Male to 1/8BSP Female	15,000psi
HSPAM20M-3BSPF	Adapters M20×1.5 Male to 3/8BSP Female	15,000psi
HSPAM20M-M10F	Adapters M20×1.5 Male to M10×1.0 Female	15,000psi
HSPAM20M-M20F	Adapters M20×1.5 Male to M20×1.5 Female	15,000psi

HSPA02-NPT(Hand-tight quick connectors)

1/4NPT male to various hand-tight quick connectors(10pcs,case included)

Model	Description	Max Pressure
HSPANPTM4-2NPTF	Adapters 1/4NPT Male to 1/2NPT Female	15,000psi
HSPANPTM4-4NPTF	Adapters 1/4NPT Male to 1/4NPT Female	15,000psi
HSPANPTM4-8NPTF	Adapters 1/4NPT Male to 1/8NPT Female	15,000psi
HSPANPTM4-3NPTF	Adapters 1/4NPT Male to 3/8NPT Female	15,000psi
HSPANPTM4-2BSPF	Adapters 1/4NPT Male to 1/2BSP Female	15,000psi
HSPANPTM4-4BSPF	Adapters 1/4NPT Male to 1/4BSP Female	15,000psi
HSPANPTM4-8BSPF	Adapters 1/4NPT Male to 1/8BSP Female	15,000psi
HSPANPTM4-3BSPF	Adapters 1/4NPT Male to 3/8BSP Female	15,000psi
HSPANPTM4-M10F	Adapters 1/4NPT Male to M10×1.0 Female	15,000psi
HSPANPTM4-M20F	Adapters 1/4NPT Male to M20×1.5 Female	15,000psi

HSPA18(Designed for all pressure comparator)

M20×1.5 Male/Female to various connectors as follows(18pcs,case included)

Model	Description	Max Pressure
HSPAM20M-4NPTF	Adapters M20×1.5 Male to 1/4NPT Female	15,000psi
HSPAM20M-4NPTM	Adapters M20×1.5 Male to 1/4NPT Male	15,000psi
HSPAM20M-3NPTF	Adapters M20×1.5 Male to 3/8NPT Female	15,000psi
HSPAM20M-3NPTM	Adapters M20×1.5 Male to 3/8NPT Male	15,000psi
HSPAM20M-2NPTF	Adapters M20×1.5 Male to 1/2NPT Female	15,000psi
HSPAM20M-2NPTM	Adapters M20×1.5 Male to 1/2NPT Male	15,000psi
HSPAM20M-3BSPF	Adapters M20×1.5 Male to 3/8BSP Female	15,000psi
HSPAM20M-3BSPM	Adapters M20×1.5 Male to 3/8BSP Male	15,000psi
HSPAM20M-2BSPF	Adapters M20×1.5 Male to 1/2BSP Female	15,000psi
HSPAM20M-2BSPM	Adapters M20×1.5 Male to 1/2BSP Male	15,000psi
HSPAM20M-3BSPTF	Adapters M20×1.5 Male to 3/8BSPT Female	15,000psi
HSPAM20M-3BSPTM	Adapters M20×1.5 Male to 3/8BSPT Male	15,000psi
HSPAM20M-2BSPTF	Adapters M20×1.5 Male to 1/2BSPT Female	15,000psi
HSPAM20M-2BSPTM	Adapters M20×1.5 Male to 1/2BSPT Male	15,000psi
HSPAM20M-M14F	Adapters M20×1.5 Male to M14×1.5 Female	15,000psi
HSPAM20M-M20F	Adapters M20×1.5 Male to M20×1.5 Female	15,000psi
HSPAM20M-M16F	Adapters M20×1.5 Male to M16×1.5 Female	15,000psi
HSPAM20M-M20M	Adapters M20×1.5 Male to M20×1.5 Male	15,000psi

HSPA64(Designed for all pressure comparator)



M20×1.5 Male/Female to various connectors as follows(64pcs,case included)

Model	Description	Max Pressure
HSPAM20M-M8F	Adapter M20×1.5 Male to M8×1 Female	15,000psi
HSPAM20M-M8M	Adapter M20×1.5 Male to M8×1 Male	15,000psi
HSPAM20M-M20F	Adapter M20×1.5 Male to M20×1.5 Female	15,000psi
HSPAM20M-M20M	Adapter M20×1.5 Male to M20×1.5 Male	15,000psi
HSPAM20M-8BSPF	Adapter M20×1.5 Male to 1/8BSP Female	15,000psi
HSPAM20M-8BSPM	Adapter M20×1.5 Male to 1/8BSP Male	15,000psi
HSPAM20M-8BSPTF	Adapter M20×1.5 Male to 1/8BSPT Female	15,000psi
HSPAM20M-8BSPTM	Adapter M20×1.5 Male to 1/8BSPT Male	15,000psi
HSPAM20M-M10F	Adapter M20×1.5 Male to M10×1 Female	15,000psi
HSPAM20M-M10M	Adapter M20×1.5 Male to M10×1 Male	15,000psi
HSPAM20M-M22F	Adapter M20×1.5 Male to M20×2 Female	15,000psi
HSPAM20M-M22M	Adapter M20×1.5 Male to M20×2 Male	15,000psi
HSPAM20M-4BSPF	Adapter M20×1.5 Male to 1/4BSP Female	15,000psi
HSPAM20M-4BSPM	Adapter M20×1.5 Male to 1/4BSP Male	15,000psi
HSPAM20M-4BSPTF	Adapter M20×1.5 Male to 1/4BSPT Female	15,000psi
HSPAM20M-4BSPTM	Adapter M20×1.5 Male to 1/4BSPT Male	15,000psi
HSPAM20M-M12F	Adapter M20×1.5 Male to M12×1.25 Female	15,000psi
HSPAM20M-M12M	Adapter M20×1.5 Male to M12×1.25 Male	15,000psi
HSPAM20M-8NPTF	Adapter M20×1.5 Male to 1/8NPT Female	15,000psi
HSPAM20M-8NPTM	Adapter M20×1.5 Male to 1/8NPT Male	15,000psi
HSPAM20M-2BSPF	Adapter M20×1.5 Male to 1/2BSP Female	15,000psi
HSPAM20M-2BSPM	Adapter M20×1.5 Male to 1/2BSP Male	15,000psi
HSPAM20M-2BSPTF	Adapter M20×1.5 Male to 1/2BSPT Female	15,000psi
HSPAM20M-2BSPTM	Adapter M20×1.5 Male to 1/2BSPT Male	15,000psi
HSPAM20M-M14F	Adapter M20×1.5 Male to M14×1 Female	15,000psi
HSPAM20M-M14M	Adapter M20×1.5 Male to M14×1 Male	15,000psi
HSPAM20M-4NPTF	Adapter M20×1.5 Male to 1/4NPT Female	15,000psi
HSPAM20M-4NPTM	Adapter M20×1.5 Male to 1/4NPT Male	15,000psi
HSPAM20M-3BSPF	Adapter M20×1.5 Male to 3/8BSP Female	15,000psi
HSPAM20M-3BSPM	Adapter M20×1.5 Male to 3/8BSP Male	15,000psi

Model	Description	Max Pressure
HSPAM20M-M14F	Adapter M20×1.5 Male to M14×1.5 Female	15,000psi
HSPAM20M-M14M	Adapter M20×1.5 Male to M14×1.5 Male	15,000psi
HSPAM20M-2NPTF	Adapter M20×1.5 Male to 1/2NPT Female	15,000psi
HSPAM20M-2NPTM	Adapter M20×1.5 Male to 1/2NPT Male	15,000psi
HSPAM20M-3BSPTF	Adapter M20×1.5 Male to 3/8BSPT Female	15,000psi
HSPAM20M-3BSPTM	Adapter M20×1.5 Male to 3/8BSPT Male	15,000psi
HSPAM20M-M16F	Adapter M20×1.5 Male to M16×1.5 Female	15,000psi
HSPAM20M-M16M	Adapter M20×1.5 Male to M16×1.5 Male	15,000psi
HSPAM20M-3NPTF	Adapter M20×1.5 Male to 3/8NPT Female	15,000psi
HSPAM20M-3NPTM	Adapter M20×1.5 Male to 3/8NPT Male	15,000psi
HSPAM20M-TM6	Adapter M20×1.5 Male to turriiformΦ6	15,000psi
HSPAM20M-TM8	Adapter M20×1.5 Male to turriiformΦ8	15,000psi
HSPAM20F-3BSPM	Adapter M20×1.5 Female to 3/8BSP Male	15,000psi
HSPAM20F-3BSPTM	Adapter M20×1.5 Female to 3/8BSPT Male	15,000psi
HSPAM20F-3NPTM	Adapter M20×1.5 Female to 3/8NPT Male	15,000psi
HSPAM20F-4BSPM	Adapter M20×1.5 Female to 1/4BSP Male	15,000psi
HSPAM20F-2BSPM	Adapter M20×1.5 Female to 1/2BSP Male	15,000psi
HSPAM20F-8NPTM	Adapter M20×1.5 Female to 1/8NPT Male	15,000psi
HSPAM20F-4BSPTM	Adapter M20×1.5 Female to 1/4BSPT Male	15,000psi
HSPAM20F-2BSPTM	Adapter M20×1.5 Female to 1/2BSPT Male	15,000psi
HSPAM20F-4NPTM	Adapter M20×1.5 Female to 1/4NPT Male	15,000psi
HSPAM20F-2NPTM	Adapter M20×1.5 Female to 1/2NPT Male	15,000psi
HSPAM20F-TM6	Adapter,M20×1.5 Female to turriiformΦ6	15,000psi
HSPAM20F-TM8	Adapter,M20×1.5 Female to turriiformΦ8	15,000psi
Ptfе gasket 20pcs,O ring 30pcs,high pressure hose 1pc,low pressure hose 1pc		
Fast Insert Tee 1pc,Fast Screw Tee 1pc		
Adjustable Wrench (10" ~ 250mm)		
General Pointer puller		
ptfе tape		
Fast Angle thread /Angle thread for back connection		

HX1039 Oil-water separator

Using:

This products mainly used for Oxygen gauge, Acetylene Meter and other non-oil instrument, also can be used to maintenance, cleaning, isolation pollution and corrosion Protection and so on.



Specification:

- Pressure range: (0~600/700)bar
- Dimension: $\Phi 88 \times 189$ mm
- Connection: M20*1.5
- Compressed volume cavity: 137ml
- Working media: Water, Transform oil , Non corrosive liquid.



HX2011 Oil-gas separator

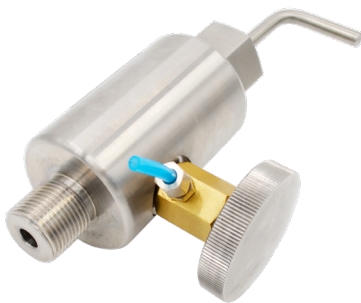

Function

HX2011 is mainly used for Gas-Liquid separation , to separate the liquid from instruments with a small amount of Liquid, without polluting the air pressure comparators.

Technical

- Pressure range: (0~100)bar
- Connector: Up connector is M20*1.5 female, down end is M20*1.5 male

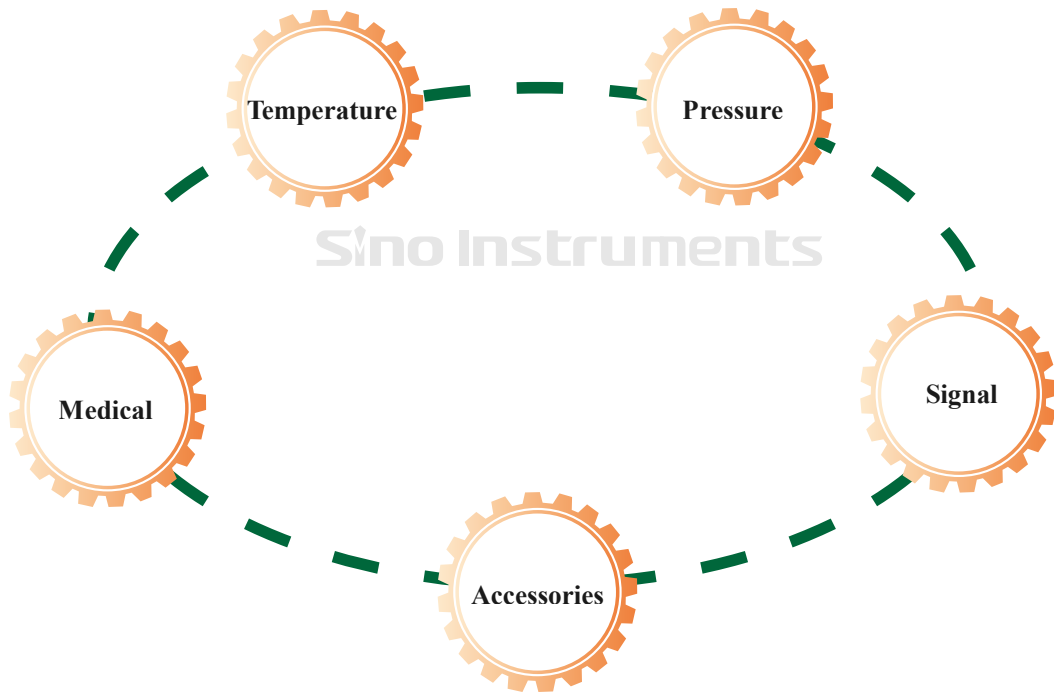

HUAXIN INSTRUMENT(BEIJING)CO.,LTD

Add:No.11,Chuangxin road,Changping,Beijing,102200,China.

E-mail:sales-huaxin@comeonhs.com/Web:www.sino-instruments.com

Tel:+86-10-62392087/Fax:+86-10-62345183