



PIUMA®

SMILE SCIENCE

Let's
go

...smile!







PIUMA[®] innovate the oral care world.
It combines design, science and functionality
to take care of your smile daily.

A handwritten signature in black ink, appearing to read "Luca" followed by a long, sweeping horizontal line that extends to the right.

MISSION

Welcome to the world of Piuma[®], where a passion for innovation meets the elegance of Italian design. Specializing in toothbrushes and toothpastes, **we've transformed daily routines into an experience of wellness and beauty.**



Our strength lies in the perfect balance between cutting-edge scientific research and refined design, crafted to provide comfort and top-notch performance.



value

ECO-FRIENDLY

We use green technology and energy from renewable resources. We strive daily in controlling our carbon footprint to create a cleaner and more sustainable world.

PIUMA IN THE WORLD



CONTINUOUS RESEARCH

Our research laboratories are in a constant dialog with the best dentists to design Piuma® products. We apply innovative solutions and technologies to offer you a unique experience.

MADE IN ITALY QUALITY

All our products are made in Italy: We package and check them in our factories to grant maximum quality, using only premium material to assure complete hygiene and cavity protection.



PIUMA: WHERE SCIENCE MEETS DESIGN

Good Design That Makes a Difference

Our toothbrushes are designed for perfect ergonomics and equipped with ultra-soft micro bristles that respect your gums while ensuring impeccable cleaning.

Each Piuma® product is made with high-quality, antibacterial, and FDA-certified materials, because safety and comfort are our priorities.



reddot design award
winner 2019





first in

DESIGN and
EFFICIENCY

100% made in Italy

Piuma® is synonymous with Italian excellence. Every step of production is carried out with artisanal care and advanced technology to offer you products to be proud of.

Choose Piuma, and transform your oral care into a ritual of innovation and beauty.

PIUMA: WHERE SCIENCE MEETS DESIGN

Visible Active[®]: The Evolution of Oral Beauty Care

At the heart of our technology is **Visible Active[®]**, an **exclusive combination of natural active ingredients** designed to care for your smile gently and effectively. This innovation is found both in our toothpastes and within the bristles of our toothbrushes, gradually releasing beneficial substances to ensure deep cleaning and long-lasting protection.

Ingredients

ECHINACEA

Helps maintain the hygiene of gingival arches and improves bad breath. Additionally, it has anti-inflammatory and immune-boosting properties.

SCIENTIFIC RESEARCH

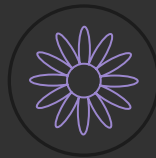
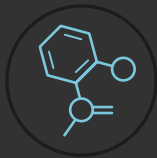

Our Natural Ingredients

VITAMIN C

Helps prevent gum problems and contributes to collagen formation for the normal function of gums.

CARBON BAMBOO

Helps restore and maintain the whiteness of your tooth enamel while combating the onset of cavities.

HYALURONIC ACID

Keeps gums healthy and helps restore their natural hyaluronic acid levels. Featuring exceptional hydrating and soothing properties.

OUR PRODUCTS

Toothbrush

Choose the PiumaBrush,
The iconic award-winning toothbrush.

Features:

Thanks to innovative design, flexibility, and extra delicate, smoothed, and ergonomic **0.1 mm micro bristles made of Tinex®**, Piuma Brush can deeply clean every part of the mouth, for a perfect smile even where you can't see!

Piuma Brush also features a tongue-cleaner, providing a multi-sensory experience for perfect tongue cleaning.

Available in two version: **Soft and Medium**

It is 100% made in Italy.

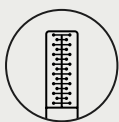
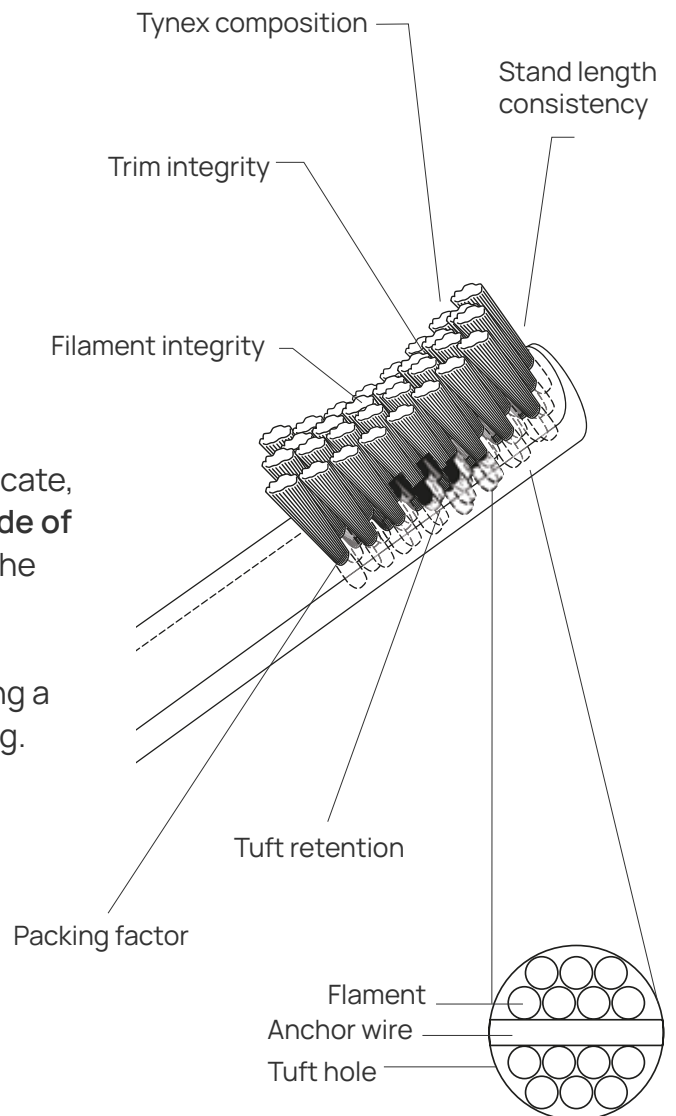

ANTIBACTERIAL MATERIALS



TAPERED HEAD

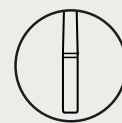

FLEXIBILITY AND COMFORT



Gradual-release bristles

With active bristles, oral care has never been this effective or innovative.

The patented active bristles are a groundbreaking innovation designed to elevate your oral care routine. **These bristles contain active ingredients within their core, which are gradually released during toothbrushing.** Each active ingredient is specifically formulated to address a particular oral care concern, ensuring a tailored approach to your dental health.

This advanced technology provides a revolutionary way to care for your oral hygiene, delivering targeted benefits with every use. When combined with the Visible Active[®] toothpaste line, the results are even more remarkable, offering a synergistic solution for a healthier, more radiant smile.

Discover all colors and choose it your favorite!



OUR PRODUCTS

Calendar Base

We've patented a revolutionary base for your Piuma Brush that not only supports your toothbrush but also **helps you keep track of when it's time for a replacement.**

Over time and with daily use, bristles wear down, and the active ingredients within them lose their effectiveness.

Using the base is simple: just use your fingers to mark the month when you started using your toothbrush.

The base will automatically indicate the month when it's time to replace it. That's it—easy and intuitive!

But this base does more than just track time.

It's been designed to physically support your toothbrush, eliminating the need for cups or other objects cluttering your sink area.

At its center, the base features a drainage system that prevents water from pooling, ensuring your bathroom stays cleaner and more hygienic.



DRAIN HOLE



REUSABLE



ANTI-SLIP RUBBER

Simple, smart, and functional!

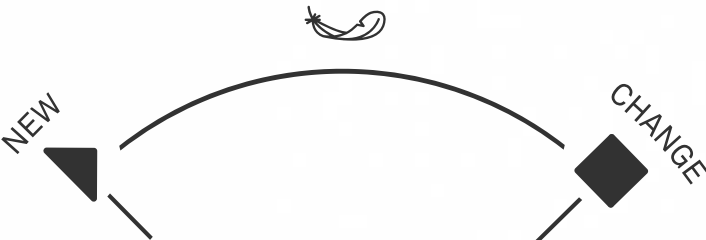

OUR PRODUCTS

Toothpaste

The Visible Active[®] toothpaste line is enriched with natural-origin active ingredients, each carefully formulated to address specific oral care needs. Whether you're looking to protect your gums, strengthen enamel, or brighten your smile, our innovative solutions provide targeted care for a healthier mouth.

Discover the power of nature combined with advanced technology, designed to make your oral hygiene routine both effective and enjoyable.



GOOD BREATH
Helps maintain the hygiene of the gingival arches and contributes to improving bad breath.
With anti-inflammatory and immunostimulant properties.

Sweet mint flavor

HEALTHY GUMS
Helps prevent the onset of gum disease and contributes to the formation of collagen.
Helps prevent the onset of tooth decay.

Sweet mint flavor





VITAL GUMS

Keeps gums healthy and helps restore their natural hyaluronic acid levels. Thanks to its moisturizing and regenerating properties, hyaluronic acid promotes gum repair, reduces inflammation.

exclusive in our line!



WHITENING

Helps restore and maintain the whiteness of teeth.
Helps prevent the onset of tooth decay.

Peppermint flavor



ANTIBACTERIAL ACTION

Supports gum health with 24K gold's antibacterial action and hyaluronic acid's hydrating and repairing benefits for a premium oral care experience.

OUR PRODUCTS

Set - Visible Active

The Visible Active sets include a toothbrush with a smart base, toothpaste, and mouthwash—all elegantly packaged in a convenient pouch. Perfect for home or travel, these sets provide a powerful boost to your oral care routine.

Enriched with natural active ingredients, they are designed to offer targeted solutions while enhancing your daily beauty ritual.

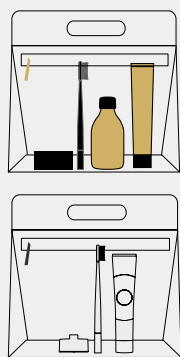

* Golden Bright

** Vitamin C
Echinacea
Bamboo Carbon





Discover them in their convenient **pouch**



OUR PRODUCTS

Mouthwash

The Piuma mouthwash line is crafted with natural active ingredients to support your oral hygiene routine every day, right in the comfort of your home. Designed to complement your brushing, these mouthwashes provide targeted care to keep your mouth fresh, healthy, and protected.

Experience the perfect balance of nature and innovation with Piuma—because a radiant smile starts with exceptional daily care.

MADE IN ITALY
100% designed and produced
in Italy.



WHITENING

This mouthwash promotes a whitening action, **allowing the natural colour of teeth to be maintained**, thanks to the effectiveness of the plant extracts it contains:

- ARTIC LICHEN for a whitening action
- BETAINE E GLYCERIN for moisturising the mucous membranes.
- ZINC CITRATE AND CHLORIDE for preventing bacterial plaque and improving hypersensitivity.
- XILITOL AND PEPPERMINT for a refreshing action.



HEALTHY GUMS

Relieves gums thanks to a combination of soothing natural extracts and **prevents gum inflammation**. Reduces gum sensitivity and, thanks to its antioxidant activity, ensures a good general physiological state for teeth and gums.

- CHAMOMILE, BISABOLOLE SAGE for a soothing action.
- RATANIA E ZINC CHLORIDE to prevent inflammatory states.
- VITAMIN C, E for an antioxidant action.
- GLYCERIN for a moisturising action.

Smile Glow

Smile Glow is the revolutionary teeth whitening kit that brightens your smile by up to 10 shades! The kit comprises:

LED LIGHT DEVICE

It is equipped with two colours of LED lights, each with different functions, which work in synergy to take care not only of your beauty, but also of your health.

WHITENING GEL

The results of the clinical study were excellent: after 14 days of treatment, an improvement of up to 10 tones was demonstrated (the average is 6 tones).

BOX

Practical case to hold the LED lighting device and USB charging cable.

BRUSH

Practical brush for applying Whitening Gel.



OUR PRODUCTS

Food Supplements

Piuma introduces a line of **three carefully formulated dietary supplements designed to support oral health from the inside out.** These supplements work to help prevent and address common oral issues by delivering essential nutrients directly where they're needed most.

Whether it's strengthening your gums, supporting enamel health, or promoting a balanced oral microbiome, Piuma supplements provide an innovative, holistic approach to oral care. Because a healthy smile starts from within!



CALCIUM BALANCE

Calcium: is needed for the maintenance of normal teeth.

FORMULA

Vitamin B2: it contributes to the conservation of normal mucous membrane.

Vitamins B6, B12: contribute to the usual immune system function.

Calendula: it performs an emollient and soothing action for the mouth membrane and the tone of voice.

Biotin: it contributes to the maintenance of normal mucous membranes.



CAVIGARD

Cavigard is a food supplement for oral health.

FORMULA

Probiotic: probiotic strain with specific studies to counteract the presence of the bacterium

Vitamin C: contributes to the normal formation of Collagen for the normal functionality of the gums.

Vitamin D: contributes to normal tooth maintenance and normal bone maintenance.



SMILE BOOST

Smile Glow is a food supplement for the mouth health.

FORMULA

Vitamin B2: it contributes to the conservation of normal mucous membrane.

Vitamins B6, B12: contribute to the usual immune system function.

Calendula: it performs an emollient and soothing action for the mouth membrane and the tone of voice.

Biotin: it contributes to the maintenance of normal mucous membranes. contributes to the normal maintenance of mucous membranes.

SWAROVSKI SPECIAL EDITION



BERNINI SPECIAL EDITION





PIUMA®

Via Pitagora n.10
30020 Noventa di Piave
Venice - ITALY
P.IVA: 04532430271
customerservice@piumacare.com
www.piumacare.com



@piumacare